

Kensington®

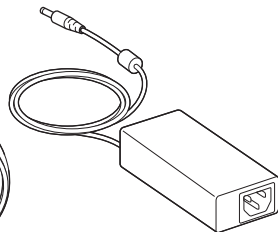

LD4650P Single-User USB-C Dock with K-Fob™ Smart Lock

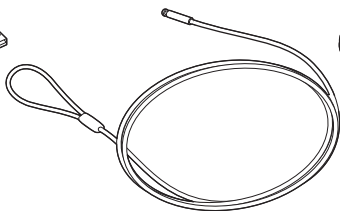
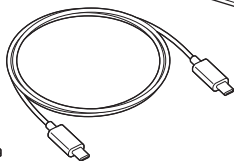
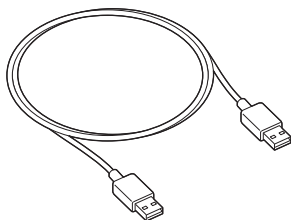
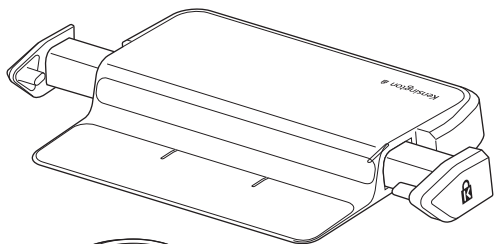
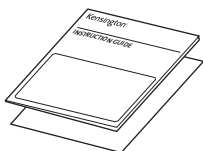

NA

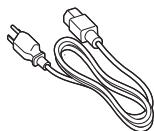

EU

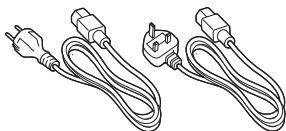

AU

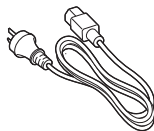

JP

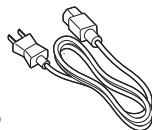

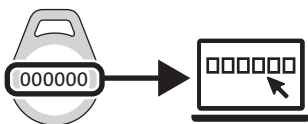

kensington.com/register

#

--	--	--	--	--	--

1

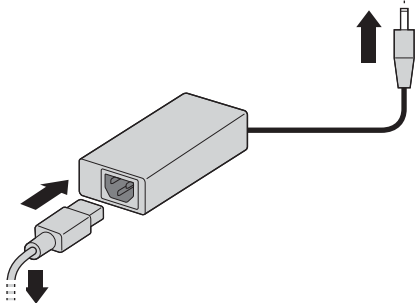
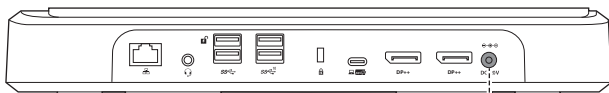

NA



EU

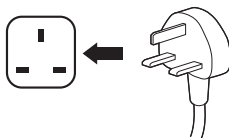

AU

中国



JP

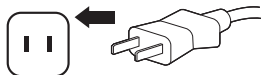



- GB** Do not disable the protective ground/earth pin of power cord.
- DE** Deaktivieren Sie den Schutzleiter-/Erdungsstift des Netzkabels nicht.
- FR** Ne détachez pas la broche de terre protectrice du cordon d'alimentation.
- NL** Stel de beschermende aardpin van de stroomkabel niet buiten werking.
- ES** No desconecte la clavija protectora de tierra del cable de alimentación.
- IT** Non scollegare la presa del cavo di messa a terra protettiva.
- PT** Não desative o pino de proteção de terra/massa do cabo de alimentação.
- DK** Det beskyttende jordforbindelsesben må ikke deaktiveres på strømkkablet.
- NO** Ikke deaktiver den beskyttende jordingspinnen på strømledningen.
- SE** Avaktivera inte det skyddande jordstiftet på nätkabeln.
- FI** Älä poista virtajohdon maadoitusnastaa käytöstä.
- EE** Ärge blokeerige toitejuhtme kaitsvat maandust / maanduskontakti.
- LV** Neatspējojiet strāvas kabeļa aizsargzemējuma kontakttapiņu.
- LT** Neatjunkite maitinimo laido apsauginio žeminimo kontakto.
- PL** Nie demontować wtyku uziemiaenia w kablu zasilającym.
- CZ** Kolík ochranného uzemnění na napájecím kabelu neodstraňujte.
- SK** Nepoškodzujte ochranný kolík uzemnenia/ukostrenia na napájacom kábli.
- HU** Ne iktassa ki a tápkábel földelővezetékét.
- RO** Nu dezinstalați acul de împământare de protecție al cablului de alimentare.
- RU** Не отсоединяйте контакт защитного заземления кабеля питания.
- UA** Не вимикайте захисний занулений/заземлений контактний роз'єм шнура живлення.
- KZ** Қуат сыманың қорғаныстық жерге тұйықтау сырығын ажыратпаңыз.
- TR** Güç kablosunun koruyucu topraklama pimini devre dışı bırakmayın.
- GR** Μην απενεργοποιείτε τον προστατευτικό ακροδέκτη γείωσης από το καλώδιο τροφοδοσίας.
- CN** 不要让电源线的接地保护/接地插脚失效。
- JP** 電源コードの保安用接地/アースピンを無効にしないでください。
- AE** يجب تشغيل مورد الطاقة الخارجي فقط مع وصلة أرضية/تأريض وقائية.

2

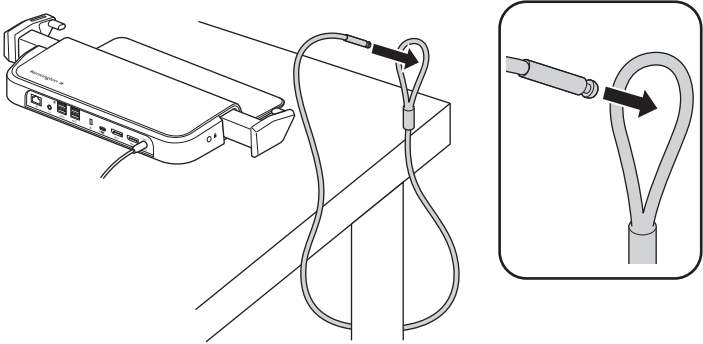

3

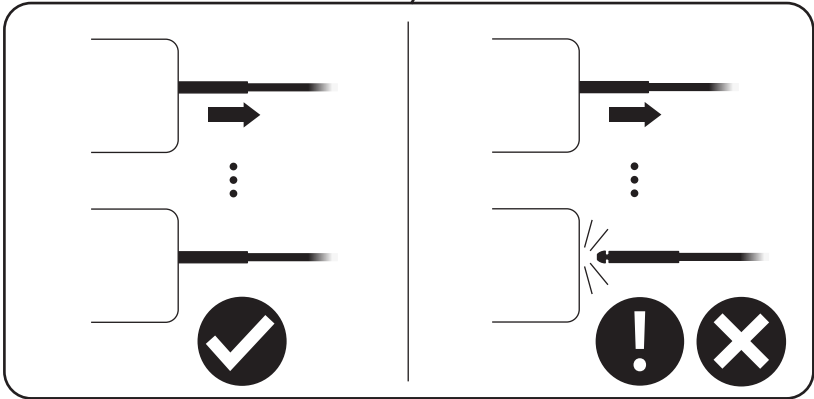
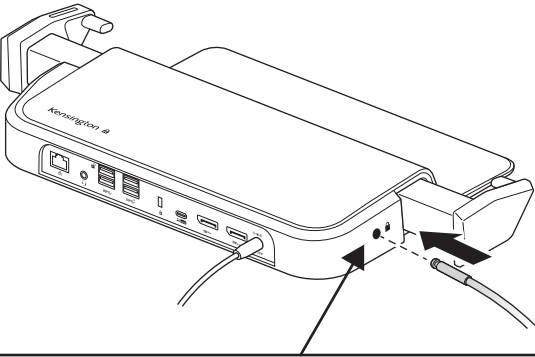

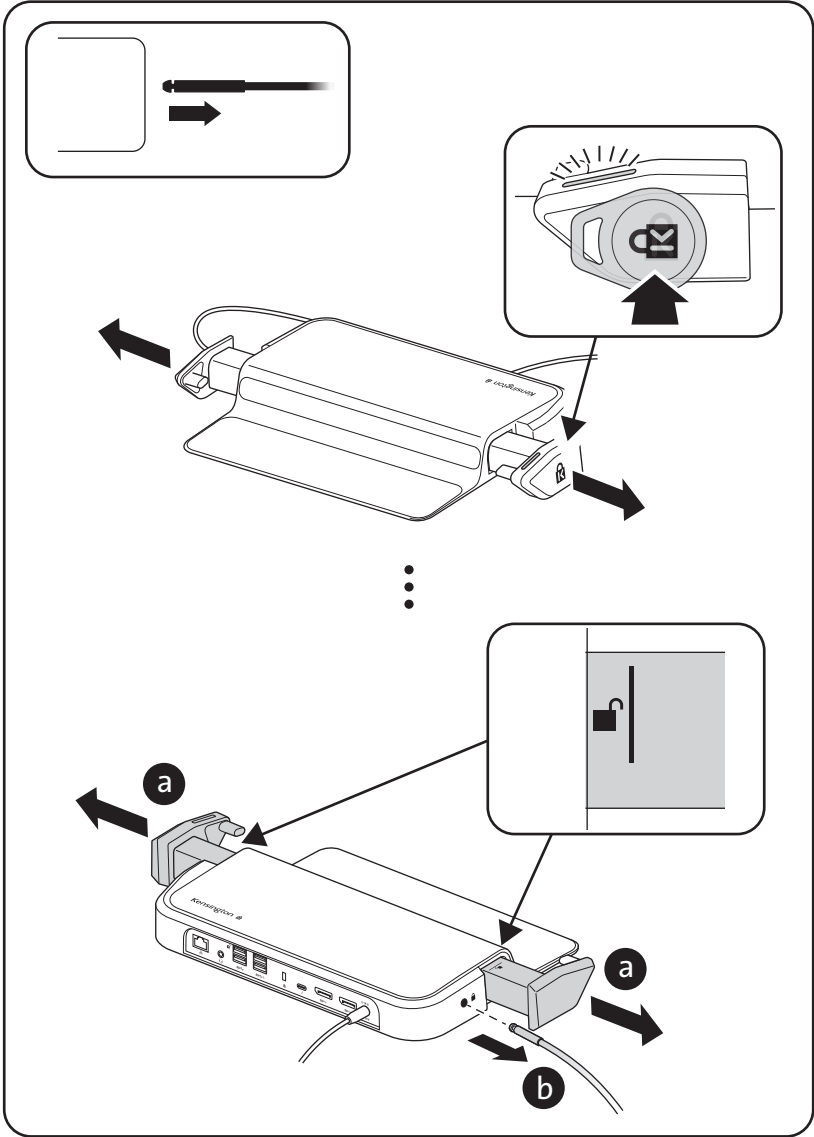

4 



5 

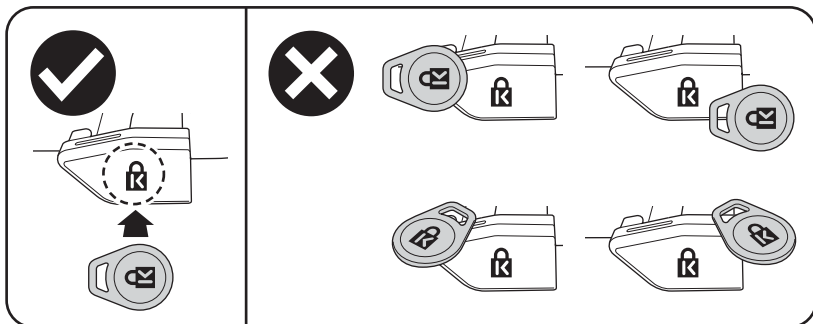
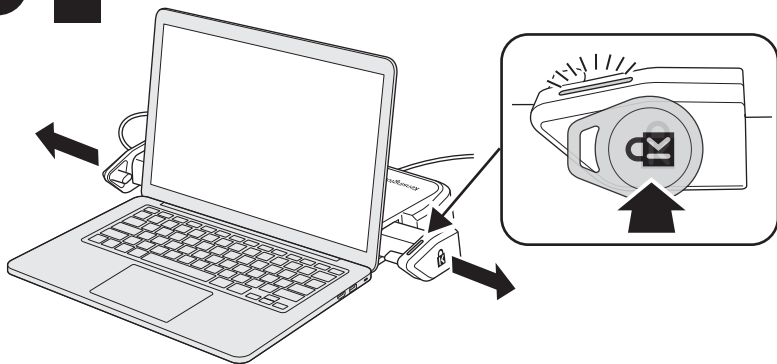

GB

LED Color	Status
Green	Lock
Blue	Unlock
Red (Flashes 4X)	Error (wrong fob)

DE

LED-Farbe	Status
Grün	Schließen
Blau	Öffnen
Rot (blinkt 4 x)	Fehler (falscher K-Fob)

FR

Couleur du voyant	État
Vert	Verrouillage
Bleu	Déverrouillage
Rouge (clignote 4 fois)	Erreur (clé incorrecte)

NL

Led-kleur	Status
Groen	Vergrendelen
Blauw	Ontgrendelen
Rood (knippert vier keer)	Fout (incorrecte Fob)

ES

Color LED	Estado
Verde	Bloqueado
Azul	Desbloqueado
Rojo (4x intermitentes)	Error (llave incorrecta)

IT

Colori LED	Status
Verde	Blocca
Blu	Sblocca
Rosso (lampeggia 4 volte)	Errore (portachiavi errato)

PT

Cor do LED	Estado
Verde	Bloqueado
Azul	Desbloqueado
Vermelho (pisca 4x)	Erro (chave incorreta)

DK

LED-farve	Status
Grøn	Lås
Blå	Lås op
Rød (Blinker 4X)	Fejl (Forkert Fob)

NO

LED-farge	Status
Grønn	Låse
Blå	Låse opp
Rød (blinker fire ganger)	Feil (feil fob)

SE

LED-färg	Status
Grön	Låsa
Blå	Låsa upp
Röd (blinker 4 gånger)	Fel (fel Fob)

FI

LED-väri	Tila
Vihreä	Lukitus
Sininen	Poista lukitus
Punainen (välähtää 4x)	Virhe (väärällinen Fob)

EE

Leedi värv	Olek
Roheline	Lukustus
Sinine	Lukust vabastus
Punane (vilgub 4 korda)	Tõrge (vale ripats)

LV

LED krāsa	Statuss
Zāla	Blockēt
Zila	Atbloķēt
Sarkana (mirgo 4 reizes)	Kļūda (nepareiza atslēga)

LT

LED spalva	Būsena
Žalia	Užrakinti
Mėlyna	Atrakinti
Raudona (mirksi 4 k.)	Klaida (netinkamas pakabukas)

PL

Kolor LED	Status
Zielony	Blokada
Niebieski	Odblokowanie
Czerwony (miga 4x)	Błąd (nieprawidłowy klucz)

CZ

Barva kontrolky LED	Status
Zelená	Zamknout
Modrá	Odemknout
Červená (4x zabliká)	Chyba (nesprávný zámek K-Fob)

SK

Farby LED	Stav
zelená	zamknúť
modrá	odomknúť
červená (blesk 4X)	Chyba (neprávny zámok)

HU

LED színe	Állapot
Zöld	Zár
Kék	Felold
Piros (4-szer villan fel)	Hiba (rossz FOB)

RO

Culoare LED	Stare
Verde	Blocare
Albastru	Deblocare
Roșu (Se aprinde intermitent 4X)	Eroare (Element fob greșit)

RU

Цвет индикатора	Состояние
Зеленый	Заблокировано
Синий	Разблокировано
Красный (мигает 4 раза)	Ошибка (неправильный Fob)

UA

Колір світлодіодного індикатора	Статус
Зелений	Заблоковано
Синій	Розблоковано
Червоний (блимає 4 рази)	Помилка (неправильний брелок-контролер)

KZ

Жарықдиод түсі	Статус
Жасыл	Құлыптау
Көк	Құлыпты ашу
Қызыл (4 рет жыпылықтайды)	Қате (жарамсыз кілт)

TR

LED Rengi	Durum
Yeşil	Kilitli
Mavi	Kilitli Değil
Kirmizi (4 Kez Yanıp Söner)	Hata (Yanlış Anahtarlık)

GR

Χρώμα LED	Κατάσταση
Πράσινο	Κλειδωμένο
Μπλε	Ξεκλειδωμένο
Κόκκινο (Αναβοσβήνει 4X)	Σφάλμα (λανθασμένο fob)

CN

LED 指示灯颜色	状态
绿色	锁定
蓝色	解锁
红色 (闪烁 4 次)	错误 (错误密钥终端)

JA

LED の色	ステータス
緑	ロック
青	ロック解除
赤 (4 回点滅)	エラー (誤ったフォブ)

AE

LED لون	الحالة
أخضر	قفل
أزرق	فتح القفل
أحمر (يوميض 4 مرات)	خطأ (مفتاح أمان غير صحيح)

#8 / M4

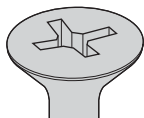

- | | |
|-----------------------------------|------------------------------------|
| GB * Sold separately | PL * Sprzedawane oddzielnie |
| DE * Separat erhältlich | CZ * Prodává se samostatně |
| FR * Vendu séparément | SK * Predáva sa samostatne |
| NL * Sold Separately | HU * Külön vásárolható meg |
| ES * Se vende por separado | RO * Comercializat separat |
| IT * Venduto separatamente | RU * Продаётся отдельно |
| PT * Vendido em separado | UA * Продається окремо |
| DK * Skal købes separat | KZ * Бөлек сатылады |
| NO * Selges separat | TR * Ayrıca Satılır |
| SE * Säljs separat | GR * Πωλείται ξεχωριστά |
| FI * Myydään erikseen | CN * 单独出售 |
| EE * Müüakse eraldi | JP * 別売 |
| LV * Iegādājams atsevišķi | AE * يُباع بشكل منفصل * |
| LT * Įsigijama atskirai | |

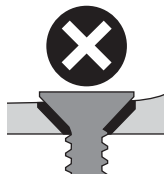
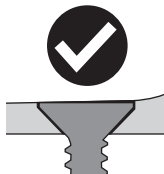
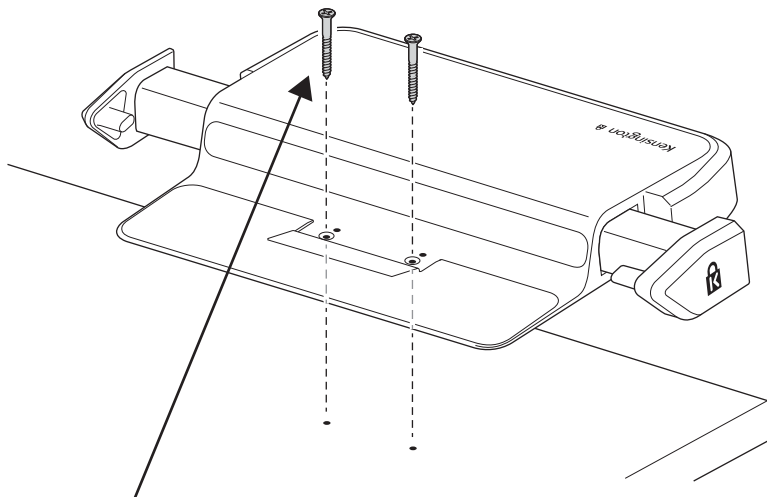

6

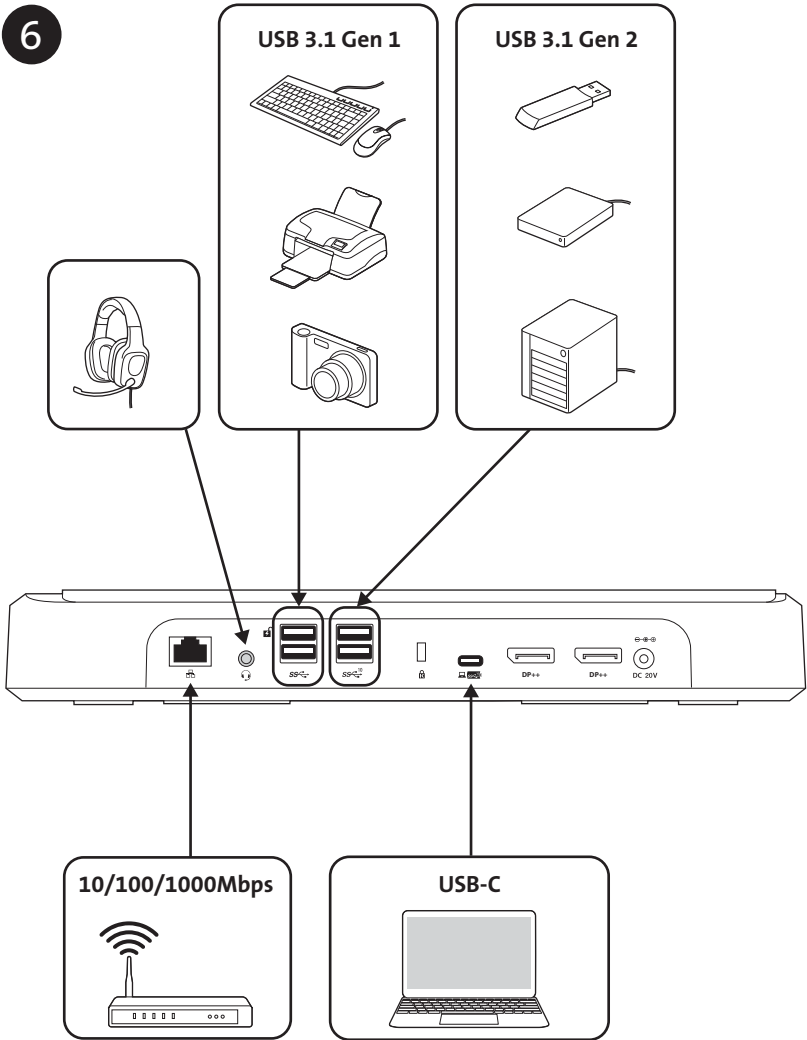

7

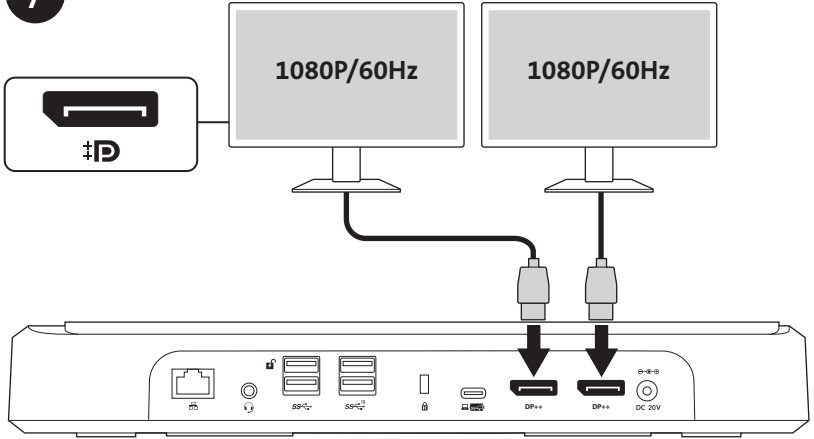

8

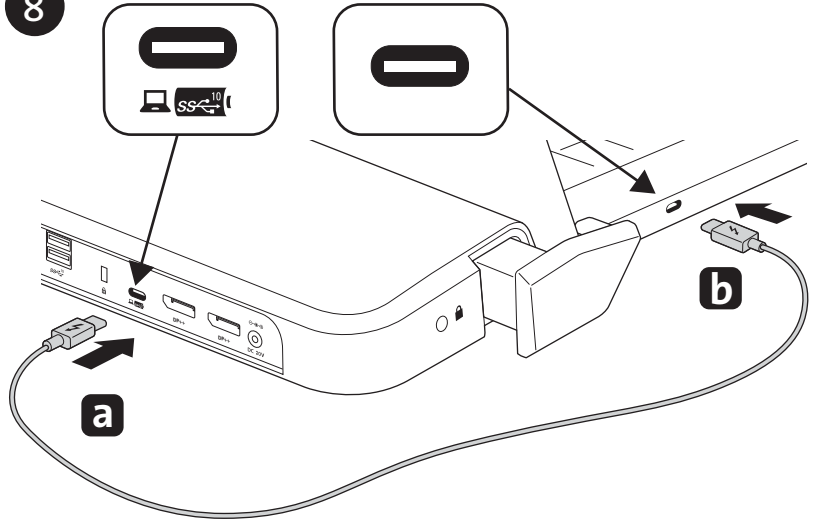

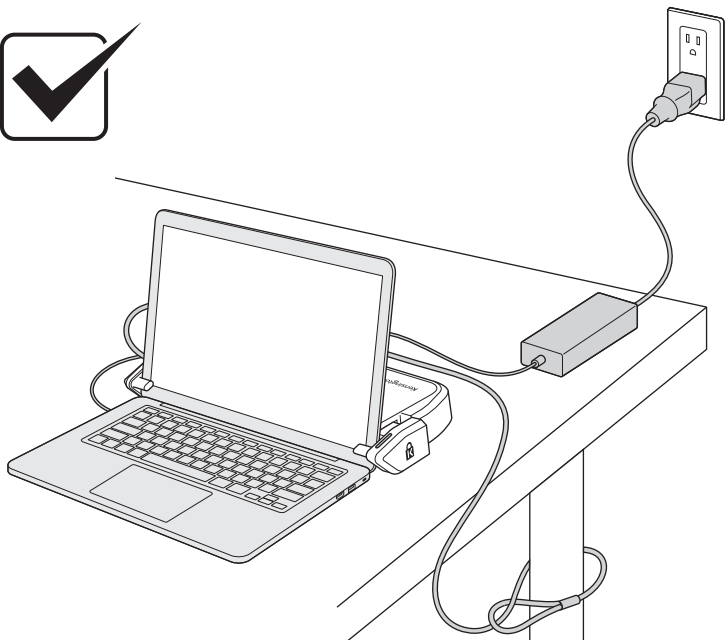

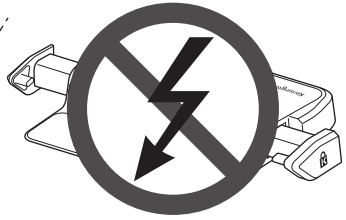
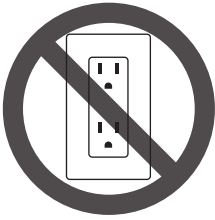

...

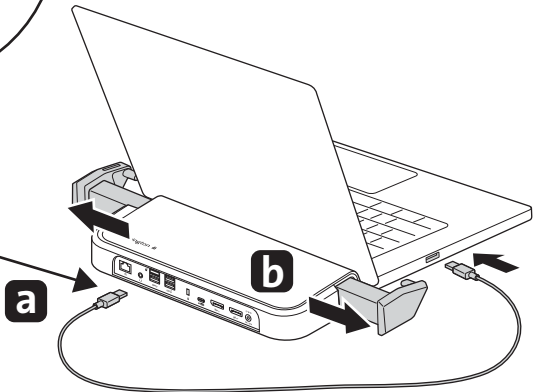
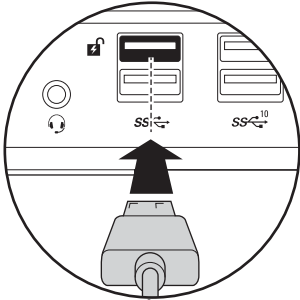



www.kensington.com/support



Australia	1300 881 931	México	55 15 00 57 00
België / Belgique	02 401 2395	Nederland	010 713 1882
Brasil	14 3235-4003	New Zealand	0800 539 26273
Canada	1 800 268 3447	Norway	80017520
中国	400 0684 219	Österreich	0800 677 873
Denmark	80 250966	Polska	22 570 18 00
Deutschland	0692 222 3654	Portugal	800855802
España	911 146 735	Россия	007 495 933 5163
Finland	0800 9 15697	Schweiz / Suisse	044 580 6667
France	01 7671 0404	Singapore	+65-6776-0195
Hong Kong	00852 2823 5130	Sweden	08 5033 6577
Hungary	06 20 9430 612	United Kingdom	0203 364 5390
Ireland	01 431 1395	United States	1 800 535 4242
Italia	02 3604 7030	International Toll	+31 53 484 9135
Japan	+81 04-7129-2135		

Kensington and ACCO are registered trademarks of ACCO Brands. All other registered and unregistered trademarks are the property of their respective owners.

© 2018 Kensington Computer Products Group, a division of ACCO Brands. Any unauthorized copying, duplicating, or other reproduction of the contents hereof is prohibited without written consent from Kensington Computer Products Group. All rights reserved. 11/18



Kensington Computer Products Group
A Division of ACCO Brands
1500 Fashion Island Blvd, 3rd Floor
San Mateo, CA 94404



ACCO Brands Europe
A Division of ACCO Brands Europe
Oxford House, Oxford Road
Aylesbury, Buckinghamshire,
HP21 8SZ United Kingdom

Importado por ACCO Mexicana
S.A. de C.V.
Circuito de la Industria Norte # 6,
Corredor Industrial Toluca Lerma,
Lerma México Cp. 52004
R.F.C. AME640229-1W3

Importer:
LEITZ ACCO Brands GmbH & Co KG
Siemensstraße 64
70469 Stuttgart
Germany

Forgalmazza:
Essetle Kft, Vaci ut 76. V. torony 1.
emelet,
1133 Budapest,
Magyarország

Импортер:
ООО "Эссельте", Россия, 125040,
Москва, 3-я улица Ямского поля,
д.18, тел.
+7(495)933-27-63
Товар не подлежит обязательной
сертификации.
Срок годности не ограничен.

アコ・ブランドズ・ジャパン株式会社
〒164-8721
東京都中野区本町1-32-2
ハーモニータワー14F
<http://www.kensington.com/jp>
E-MAIL: JP.Kensington@acco.com

ACCO Brands Canada Inc
7381 Bramalea Rd
Mississauga,
ON L5S 1C4
Canada

Acco Brands Chile S.A.,
Avda. Presidente Riesco # 5711,
oficina 201
Las Condes, Santiago,
Chile C.P. 7561114

Dystrybutor:
Essetle Polska Sp. z o.o., ul.
Przemysłowa 11A,
26-900 Kozienice

Importator:
Essetle Sales SRL, Gheorghie
Țițeica 121C,
Sector 2, București,
Romania

Өндүрүшү:
"Essetle Polska Sp. z o.o.", ul.
Przemysłowa 11A, 26-900 Kozienice
Импорттаушы: "АБДИ Компани" АҚ,
Алматы қ., Сейфуллин даңғ. 465/191"
Тауар міндетті сертификаттауды
қажет етпейді.
Жарамдылық мерзімі шектелмеген.

ACCO Brands Asia Pte Ltd
5A Toh Guan Road East #06-03,
Singapore 608830

ACCO Brands Australia - Kensington
2 Coronation Avenue
Kings Park NSW 2148
Australia

Importado e Distribuído por:
Tilibra Produtos De Papelaria Ltda.
CNPJ: 44.990.901/0001-43
Rua Aymorés, 6-9 – Baururu/SP –
Brasil CEP 17013-900

Dovozce/Dovozca:
Essetle, s.r.o., V Lužích 818,
142 00 Praha 4,
Česka republika

Дистрибутор:
Ессельте Польска Сп. з о.о.,
вулиця Пшемислова, 11А,
26-900 Козеніце
Товар не підлягає обов'язковій
сертифікації.
Термін придатності необмежений.

广州市爱珂贸易有限公司
上海分公司
中国上海市市长宁区
延安西路2299号1509室
电话: 021-61368966
传真: 021-61710161
www.accobrands.cn

Designed in California, U.S.A.
by Kensington
www.kensington.com

Made in China | Fabriqué en Chine | Fatta in Cina | Hecho en China | Fabricado em China | Κατασκευάζεται στην Κίνα | Származási ország Kína |
Fabricat in China | Сделано в Китае | Зроблено в Китаї | Қытайда өндiрiлген | صنع في الصين