

Kensington®

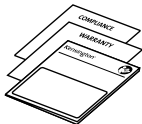

SD5780T Thunderbolt™ 4 Dual 4K Dock

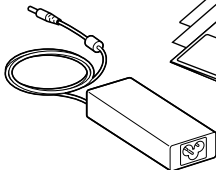
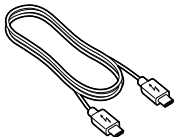
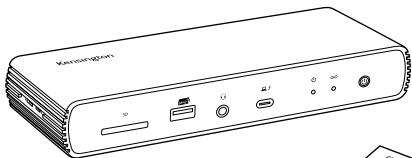

NA



EU



UK



AP



JP



[kensington.com/register](https://www.kensington.com/register)

1

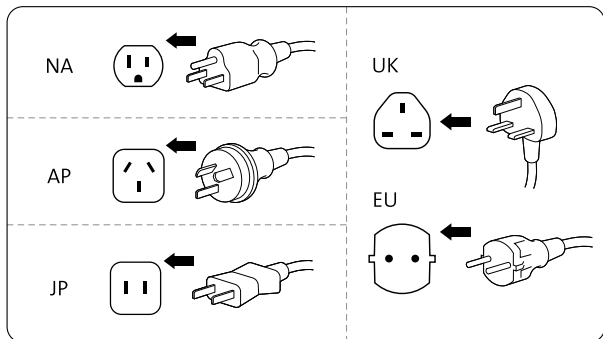
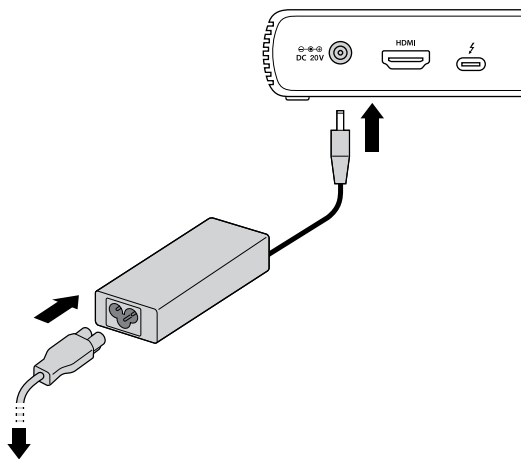

2

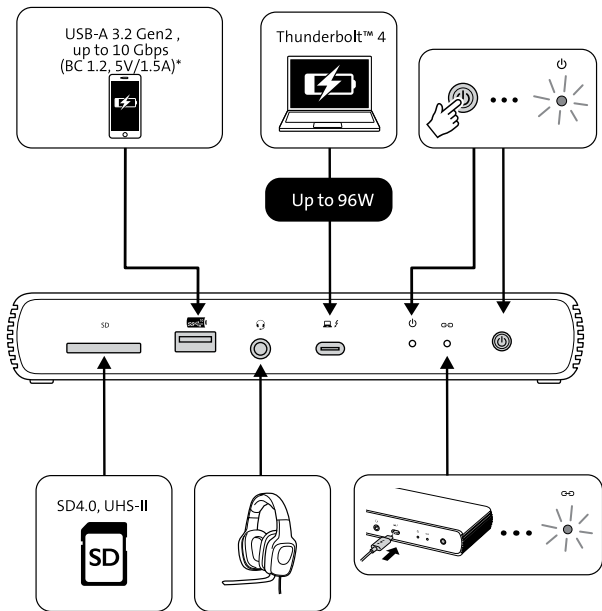

* USB Battery Charging 1.2-compliant devices

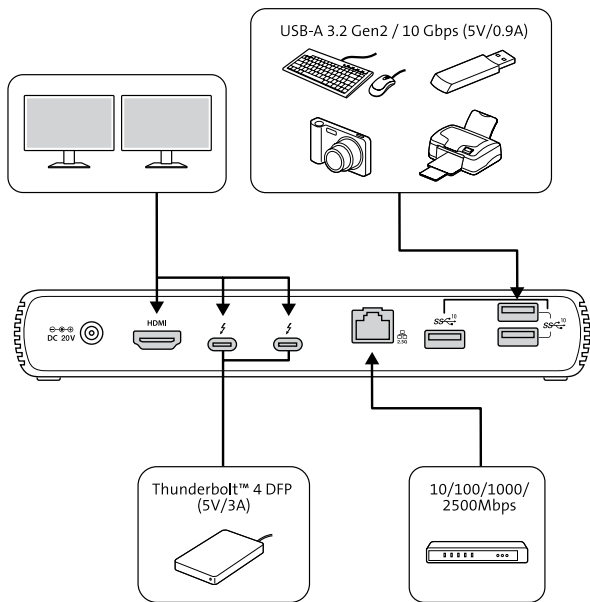



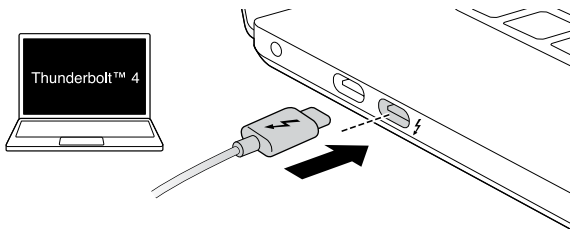

3

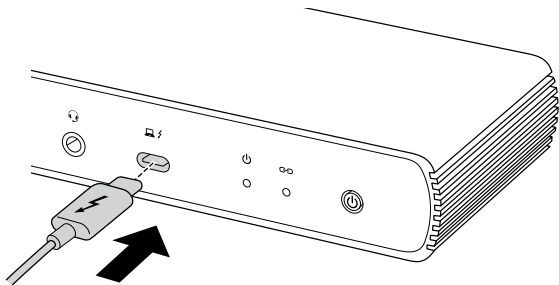

4



5

|  |  |  |  |
|---|---|---|---|
| Thunderbolt™ 3 / Thunderbolt™ 4 / USB4 (Windows) | 8K @ 60Hz* | 4K @ 60Hz | 1 x 4K up to 120Hz or 1 x 2K up to 240Hz |
| Thunderbolt™ 3 / Thunderbolt™ 4 / (macOS) | 6K @ 60Hz | 4K @ 60Hz | |
| MacBook M1 Pro / Pro Max | 6K @ 60Hz | 6K @ 60Hz | |
| USB-C Alt Mode (Windows) | 4K @ 60Hz | | |
| MacBook M1 / iPad Pro | 6K @ 60Hz | | |

* Support for Display Stream Compression (DSC) is based on the host device and monitor capabilities.

6

Initial Thunderbolt™ 4 connection for Windows

New Thunderbolt™ device have been attached

Thunderbolt™ devices were attached. In order to approve them for use this application must be run with administrator privileges.
Click OK to run the **Thunderbolt™** software with administrator privileges.

OK

Cancel

6.1 Manage Thunderbolt™ 4 devices and settings later



6.2

View Attached Devices
Approve Attached Devices ▸
Manage Approved Device

Settings
Exit



Sold separately

1

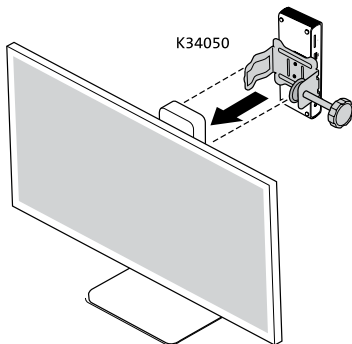

2

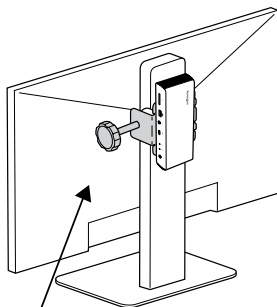

< = 13.2lbs
(< = 6.0kg)

Sold separately

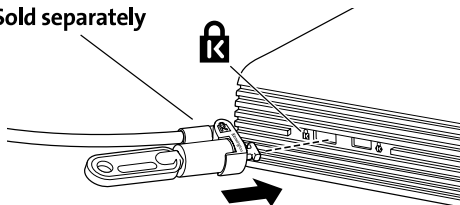

Recommended
K65020WW MicroSaver® 2.0 Keyed Lock

Sold separately

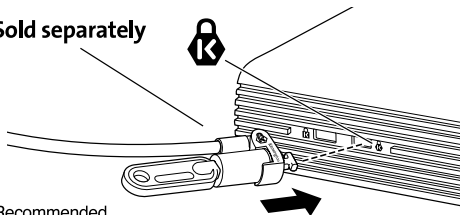

Recommended
K64444WW NanoSaver™ Keyed Laptop Lock

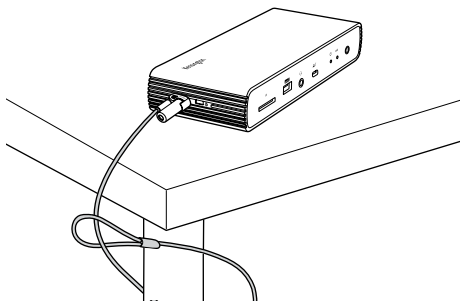



www.kensington.com/support

Kensington and the ACCO name and design are registered trademarks of ACCO Brands. All other registered and unregistered trademarks are the property of their respective owners. ©2022 Kensington Computer Products Group, a division of ACCO Brands. Any unauthorized copying, duplicating, or other reproduction of the contents hereof is prohibited without written consent from Kensington Computer Products Group. All rights reserved. 02/22

