

# Kensington®

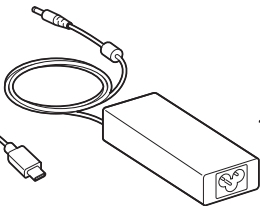

## SD4800P Universal USB-C Scalable Video Dock with Power Delivery

通用 USB-C 可扩展视频扩展坞（具备供电功能）

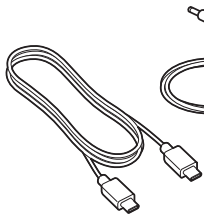

**NA**



**EU**

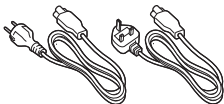

**AU**

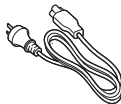

**JP**

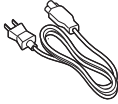



[kensington.com/register](https://kensington.com/register)

1

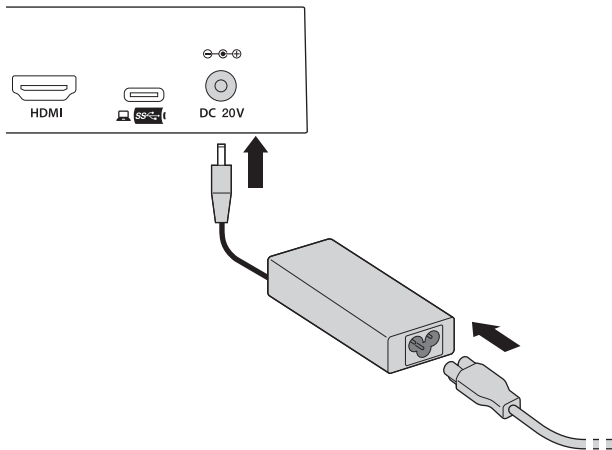

NA

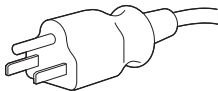

AU / 中国

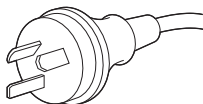

JP



EU

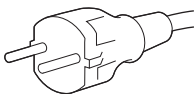
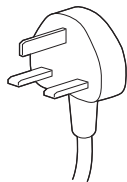

2

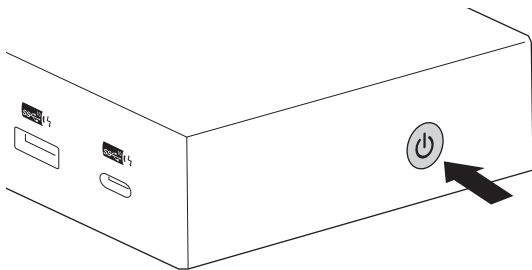

3

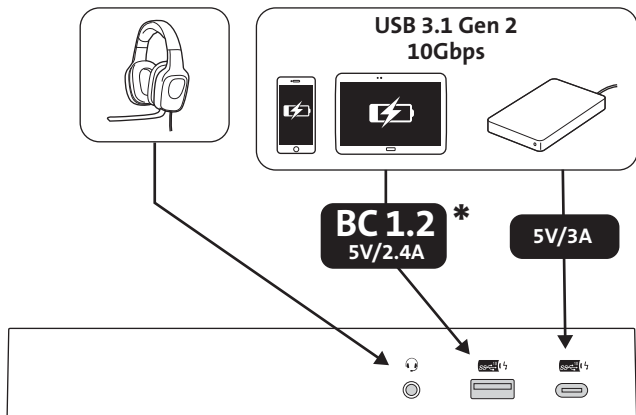

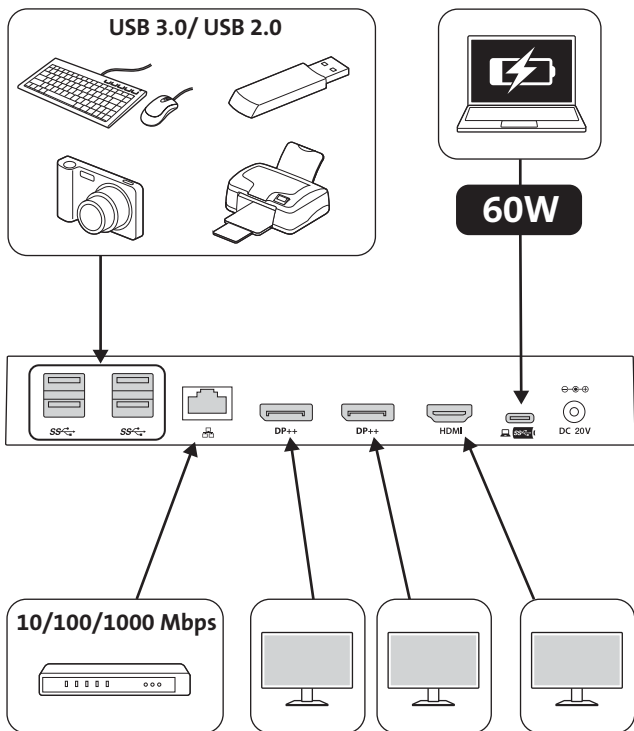

## BC 1.2 \*

- GB** \* USB Battery Charging 1.2-compliant devices
- DE** \* USB-Batterie zum Laden mit 1,2A kompatibler Geräte
- FR** \* Chargeur USB 1.2 pour les appareils conformes
- NL** \* Batterij opladen via USB 1.2-compatibele apparaten
- ES** \* Dispositivos compatibles con el cargador USB 1.2 para baterías
- IT** \* Dispositivi conformi alle specifiche USB Battery Charging 1.2
- PT** \* Dispositivos de carregamento de bateria compatíveis com USB 1.2
- DK** \* USB-batteri oplader 1.2-kompatible enheder
- NO** \* Enheter som er kompatible med USB 1.2 batterilading
- SE** \* Använd enheter kompatibla med USB-batteriladdning 1.2.
- FI** \* USB-akkulaturin 1.2 kanssa yhteensopivat laitteet
- EE** \* USB-akulaadimise standardiga 1.2 ühilduvad seadmed
- LV** \* Ar USB akumulatoru uzlādes specifkāciju 1.2 saderīgas ierīces
- LT** \* USB baterijos įkrovimas 1.2 versijos suderinamiems įrenginiams
- PL** \* Urządzenia zgodne z ładowaniem USB 1.2
- CZ** \* Zařízení podporující nabíjení baterií prostřednictvím rozhraní USB verze 1.2
- SK** \* Zariadenia podporujúce nabíjanie batérie cez USB verzie 1.2
- HU** \* USB-akkumulátortöltés 1.2-es szabványnak megfelelő eszközöknél
- RO** \* Dispozitive în conformitate cu Încărcare acumuloare prin USB 1.2
- RU** \* Зарядка аккумулятора USB 1.2 –совместимые устройства
- UA** \* Пристрої, що відповідають Плану сумісності 1.2 для заряджання акумуляторів через USB
- KZ** \* 1.2 USB батарея зарядтау пішімімен үйлесімді құрылғылар
- TR** \* USB Pil Şarjı 1.2 ile uyumlu cihazlar
- GR** \* Συσκευές συμβατές με φόρτισης μπαταρίας USB 1.2
- CN** \* USB 电池充电 1.2 兼容设备
- JP** \* USB バッテリー充電 1.2 互換機器
- AR** \* الإصدار USB 1.2 أجهزة متوافقة مع شحن بطارية \*

4



DisplayPort



DisplayPort

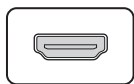
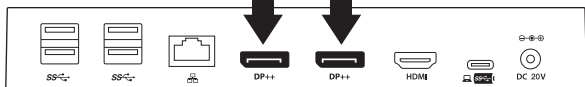

HDMI

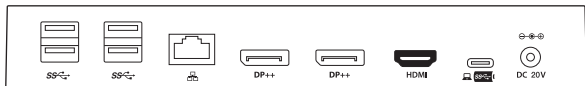
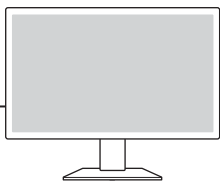

5  
a

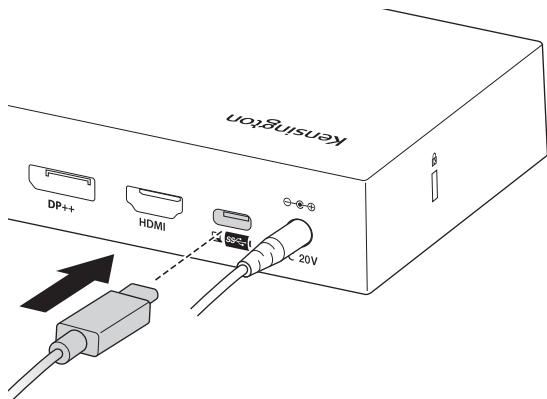

b

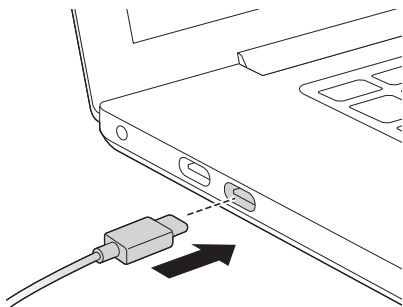



1

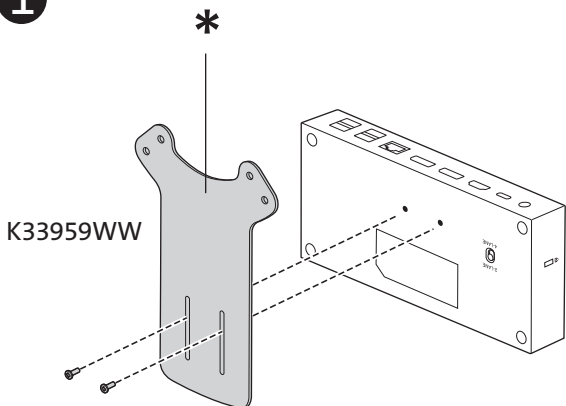

2

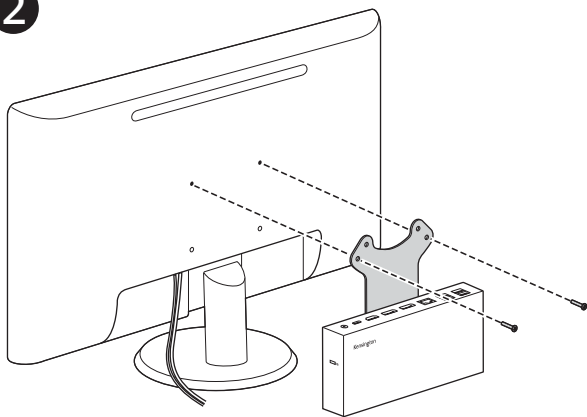

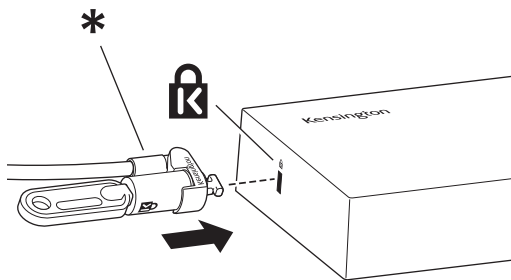

**GB** Recommended

**DE** Empfohlen

**FR** Recommandé

**NL** Recommended

**ES** Recomendado/a

**IT** Consigliato

**PT** Recomendado

**DK** Anbefales

**NO** Anbefalt

**SE** Rekommendera

**FI** Suositeltu

**EE** Soovitatud

**LV** Ieteicams

**LT** Rekomenduojama

**PL** Polecane

**CZ** Doporučeno

**SK** Odporúčané

**HU** Ajánlott

**RO** Recomandat

**RU** Рекомендуется

**UA** Рекомендовано

**KZ** Ұсынылған

**TR** Tavsiye edilen

**GR** Συνιστάται

**CN** 推荐

**JP** 推奨

**AE**

موصى به

**K65020WW MicroSaver® 2.0 Keyed Lock**

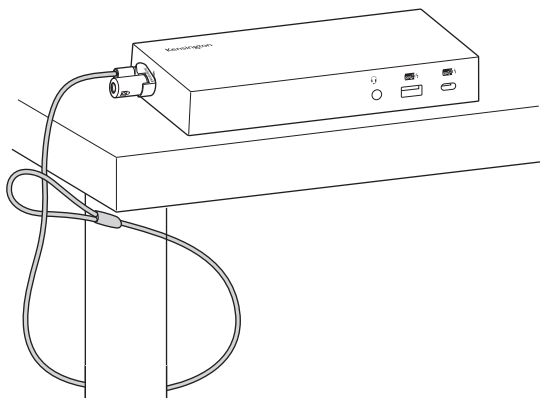

**GB** \* Sold separately

**DE** \* Separat erhältlich

**FR** \* Vendu séparément

**NL** \* Sold Separately

**ES** \* Se vende por separado

**IT** \* Venduto separatamente

**PT** \* Vendido em separado

**DK** \* Skal købes separat

**NO** \* Selges separat

**SE** \* Säljs separat

**FI** \* Myydään erikseen

**EE** \* Müüakse eraldi

**LV** \* Iegādājams atsevišķi

**LT** \* Įsigijama atskirai

**PL** \* Sprzedawane oddzielnie

**CZ** \* Prodává se samostatně

**SK** \* Predáva sa samostatne

**HU** \* Külön vásárolható meg

**RO** \* Comercializat separat

**RU** \* Продается отдельно

**UA** \* Продається окремо

**KZ** \* Бөлек сатылады







**TR** \* Ayrıca Satılır





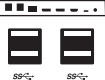

**GR** \* Πωλείται ξεχωριστά







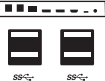

**CN** \* 单独出售

**JP** \* 別売

**AE** \* يُباع بشكل منفصل\*

1X 				
				
<b>2-LANE *</b> HBR2 (DP1.2)	<b>2560*1440 @60HZ</b> <b>3840*2160 @30HZ</b>	USB 3.1 Gen2 (10Gbps)	USB 3.1 Gen1 (5Gbps)	1000Mbps
<b>2-LANE *</b> HBR3 (DP1.3)	<b>3840*2160 @60HZ</b>			
<b>4-LANE **</b> HBR2 (DP1.2)	<b>3840 *2160 @60HZ</b>	USB 2.0 (480Mbps)	USB 2.0 (480Mbps)	100Mbps
<b>4-LANE **</b> HBR3 (DP1.3)	<b>3840*2160 @60HZ</b>			

2X 				
				
<b>2-LANE *</b> HBR2 (DP1.2)	<b>1920*1080 @60HZ</b>	USB 3.1 Gen2 (10Gbps)	USB 3.1 Gen1 (5Gbps)	1000Mbps
<b>2-LANE *</b> HBR3 (DP1.3)	<b>2560*1440 @60HZ</b>			
<b>4-LANE **</b> HBR2 (DP1.2)	<b>2560*1440 @60HZ</b>	USB 2.0 (480Mbps)	USB 2.0 (480Mbps)	100Mbps
	<b>3840*2160 @30HZ</b>			
<b>4-LANE **</b> HBR3 (DP1.3)	<b>2560*1600 @60HZ</b>			
	<b>3840*2160 @30HZ</b>			

3X 						
	 DP++	 DP++	 HDMI			
<b>2-LANE *</b> HBR2 (DP1.2)	1600*900 @60HZ	1600*900 @60HZ	1600*900 @60HZ	USB 3.1 Gen2 (10Gbps)	USB 3.1 Gen1 (5Gbps)	1000Mbps
<b>2-LANE *</b> HBR3 (DP1.3)	1920*1080 @60HZ	1920*1080 @60HZ	1920*1080 @60HZ			
<b>4-LANE **</b> HBR2 (DP1.2)	1920*1080 @60HZ	1920*1080 @60HZ	1920*1080 @60HZ	USB 2.0 (480Mbps)	USB 2.0 (480Mbps)	100Mbps
<b>4-LANE **</b> HBR3 (DP1.3)	3840*2160 @30HZ	3840*2160 @30HZ	3840*2160 @30HZ			

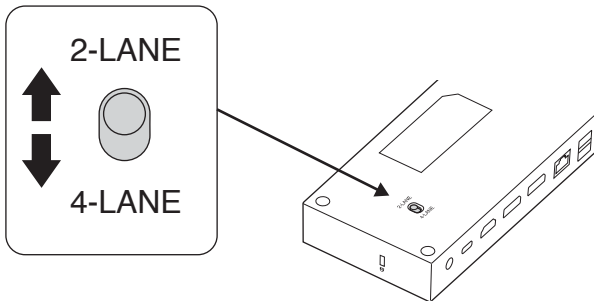

*	**
<b>GB</b> Default Mode	Video Boost Mode
<b>DE</b> Standardmodus	Video Boost-Modus
<b>FR</b> Mode par défaut	Mode d'optimisation vidéo
<b>NL</b> Standaardmodus	Videoversterkingsmodus
<b>ES</b> Modo predeterminado	Modo propulsión de vídeo
<b>IT</b> Modalità predefinita	Modalità potenziamento video
<b>PT</b> Modo predefinido	Modo de melhoramento de vídeo
<b>DK</b> Default Mode	Video Boost Mode
<b>NO</b> Std. modus	Videoboost-modus
<b>SE</b> Standardläge	Videoboostläge
<b>FI</b> Oletustila	Videotehotila
<b>EE</b> Vaikerežiim	Videovõimendusrežiim
<b>LV</b> Noklusējuma režīms	Video paātrinājuma režīms
<b>LT</b> Numatytasis režimas	Vaizdo stiprinimo režimas
<b>PL</b> Tryb wyświetlania	Tryb przyspieszenia wideo
<b>CZ</b> Výchozí režim	Režim podpory videa
<b>SK</b> Predvolený režim	Režim podpory videa
<b>HU</b> Alapértelmezett üzemmód	Video Boost mód
<b>RO</b> Modul implicit	Modul de amplificare video
<b>RU</b> Режим по умолчанию	Режим улучшения видео
<b>UA</b> Стандартний режим	Покращений режим відео
<b>KZ</b> Әдепкі режим	Видео күшейту режимі
<b>TR</b> Varsayılan Mod	Video Geliştirme Modu
<b>GR</b> Προεπιλεγμένη λειτουργία	Λειτουργία ενίσχυσης βίντεο
<b>CN</b> 默认模式	视频增强模式
<b>JP</b> デフォルトモード	ビデオブーストモード
<b>AR</b> الوضع الافتراضي	وضع تحسين الفيديو



[www.kensington.com/support](http://www.kensington.com/support)



Australia	1300 881 931	México	55 15 00 57 00
België / Belgique	02 401 2395	Nederland	010 713 1882
Brasil	14 3235-4003	New Zealand	0800 539 26273
Canada	1 800 268 3447	Norway	80017520
中国	400 0684 219	Österreich	0800 677 783
Denmark	80 250966	Polska	22 570 18 00
Deutschland	0692 222 3654	Portugal	800855802
España	911 146 735	Россия	007 495 933 5163
Finland	0800 9 15697	Schweiz / Suisse	044 580 6667
France	01 7671 0404	Singapore	+65-6776-0195
Hong Kong	00852 2823 5130	Sweden	08 5033 6577
Hungary	06 20 9430 612	United Kingdom	0203 364 5390
Ireland	01 431 1395	United States	1 800 535 4242
Italia	02 3604 7030	International Toll	+44 203 364 5390
Japan	+81 04-7129-2135		

Kensington and ACCO are registered trademarks of ACCO Brands. All other registered and unregistered trademarks are the property of their respective owners.

© 2019 Kensington Computer Products Group, a division of ACCO Brands. Any unauthorized copying, duplicating, or other reproduction of the contents hereof is prohibited without written consent from Kensington Computer Products Group. All rights reserved. 02/19



**Kensington Computer Products Group**  
A Division of ACCO Brands  
1500 Fashion Island Blvd, 3rd Floor  
San Mateo, CA 94404



#### ACCO Brands Europe

A Division of ACCO Brands Europe  
Oxford House, Oxford Road  
Aylesbury, Buckinghamshire,  
HP21 8SZ United Kingdom

#### ACCO Brands Canada Inc

7381 Bramalea Rd  
Mississauga,  
ON L5S 1C4  
Canada

#### ACCO Brands Australia - Kensington

2 Coronation Avenue  
Kings Park NSW 2148  
Australia

#### Importado por ACCO Mexicana S.A. de C.V.

Circuito de la Industria Norte # 6,  
Corredor Industrial Toluca Lerma,  
Lerma México Cp. 52004  
R.F.C. AME640229-1W3

#### Acco Brands Chile S.A.,

Avda. Presidente Riesco # 5711,  
oficina 201  
Las Condes, Santiago,  
Chile C.P. 7561114

#### Importado e Distribuído por:

Tilibra Produtos De Papelaria Ltda.  
CNPJ: 44.990.901/0001-43  
Rua Aymorés, 6-9 – Bauru/SP –  
Brasil CEP 17013-900

#### LEITZ ACCO Brands GmbH & Co KG

Siemensstraße 64  
70469 Stuttgart  
Germany

#### Dystrybutor:

Esselte Polska Sp. z o.o., ul.  
Przemysłowa 11A,  
26-900 Koźienice

#### Dovozce/Dovozca:

Esselte, s.r.o., V Lužich 818,  
142 00 Praha 4,  
Česka republika

#### Forgalmazza:

Esselte Kft, Vaci ut 76. V. torony I.  
emelet,  
1133 Budapest,  
Magyarország

#### Importator:

Esselte Sales SRL, Gheorghe  
Țițeica 121C,  
Sector 2, București,  
Romania

#### Дистрибутор:

Есселте Польска Сп. з о.о.,  
вулиця Пшемислова, 11А,  
26-900 Коженіце  
Товар не підлягає обов'язковій  
сертифікації.  
Термін придатності необмежений.

#### Импортер:

ООО "Эсселте", Россия, 125040,  
Москва, 3-я улица Ямского поля,  
д.18, тел.  
+7(495)933-27-63  
Товар не подлежит обязательной  
сертификации.  
Срок годности не ограничен.

#### Өндіруші:

"Esselte Polska Sp. z o.o.", ul.  
Przemysłowa 11A, 26-900 Koźienice  
Импорртаушы: "АБДИ Компани"  
АҚ, Алматы қ., Сейфуллин даңғ.  
465/191"  
Тауар міндетті сертификаттауды  
қажет етпейді.  
Жарамдылық мерзімі шектелмеген.

#### ACCO Brands Asia Pte Ltd

5A Toh Guan Road East #06-03,  
Singapore 608830

广州市爱珂贸易有限公司  
上海分公司  
中国上海市长宁区  
延安西路2299号1509室  
电话: 021-61368966  
传真: 021-61710161  
www.accobrand.cn

アコ・ブランド・ジャパン株式会社  
〒164-8721  
東京都中野区本町1-32-2  
ハーモニータワー14F  
http://www.kensington.com/jp  
E-MAIL: JP.Kensington@acco.com

Designed in California, U.S.A.  
by Kensington  
www.kensington.com

Made in China | Fabriqué en Chine | Fatta in Cina | Hecho en China | Fabricado em China | Κατασκευάζεται στην Κίνα |  
Számazási ország Kína | Fabricat in China | Сделано в Китае | Зроблено в Китаї | Қытайда өндірілген | صنع في الصين