

# Kensington®

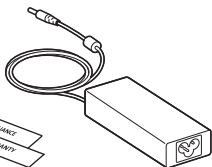

## SD4780P USB-C & USB 3.0 Dual 4K Docking Station

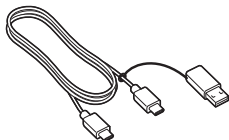
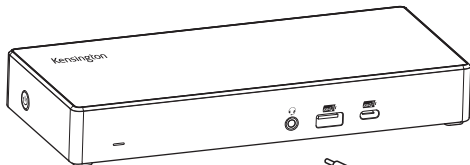

NA



EU



AP/JP



[kensington.com/register](https://www.kensington.com/register)

1

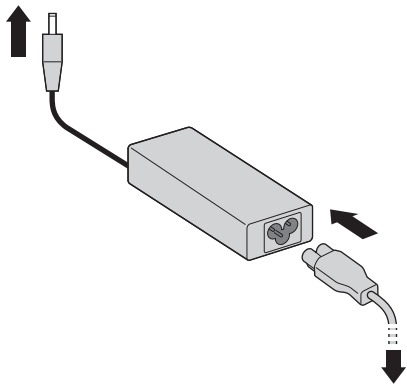

US



UK

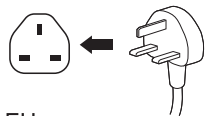

AU



EU

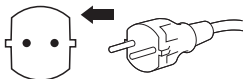

JP

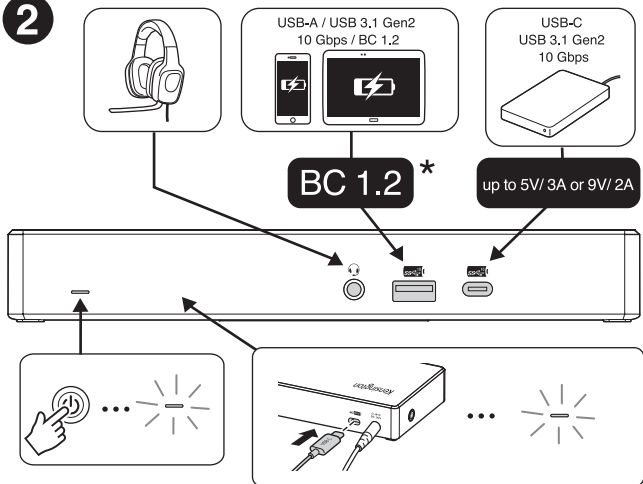

**2**

\* USB Battery Charging 1.2-compliant devices (up to 5V/ 2.4A for Apple Devices)

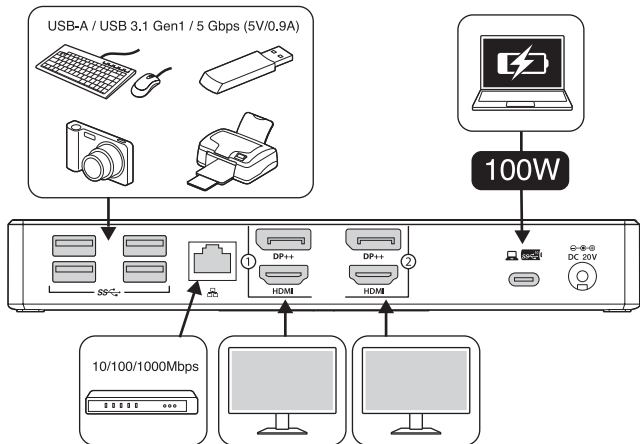

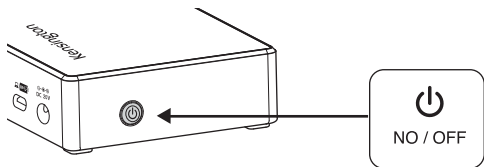

**3**

**a**

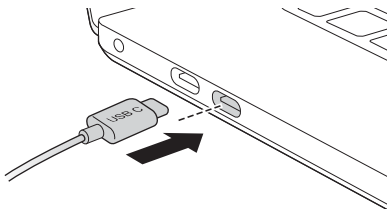

**b**

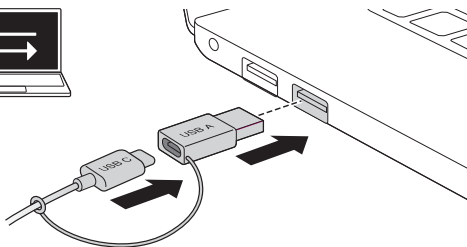
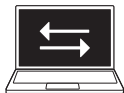

**4**

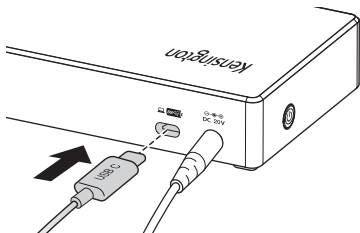

5

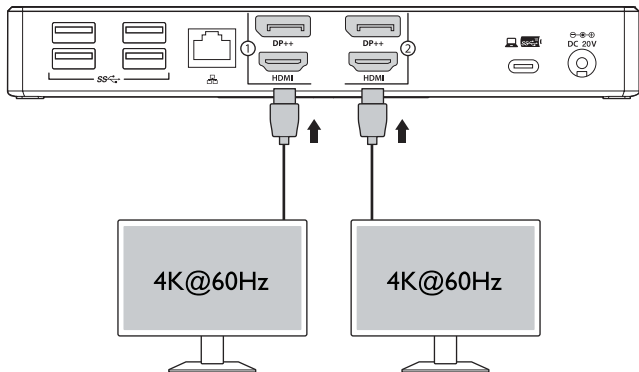
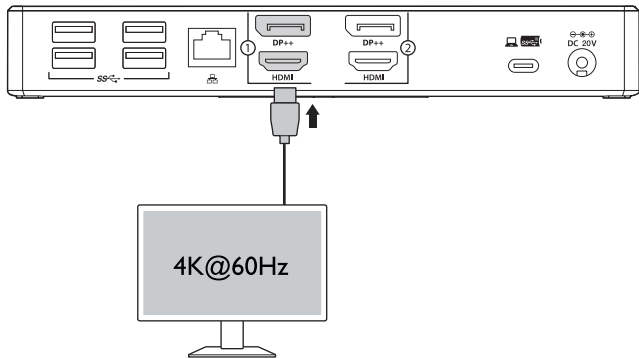

6

Windows 10 / macOS / Chrome OS



[www.kensington.com/software](http://www.kensington.com/software)  
[www.displaylink.com/downloads](http://www.displaylink.com/downloads)



Windows Update



[www.kensington.com/support](http://www.kensington.com/support)

Sold separately

1

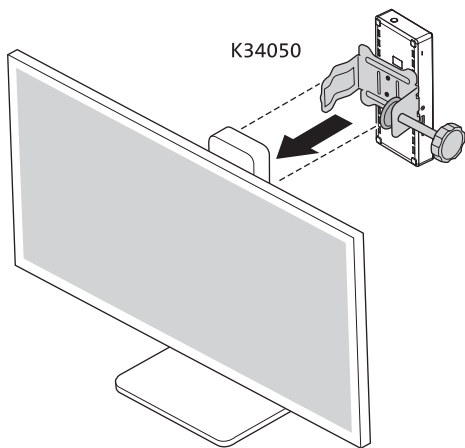

2

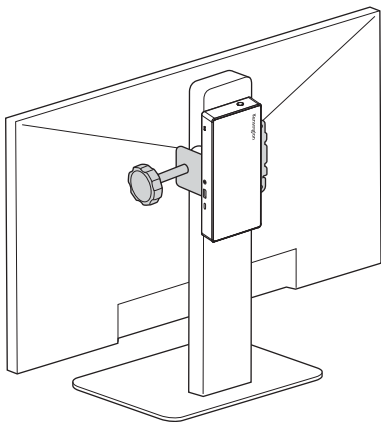

Sold separately

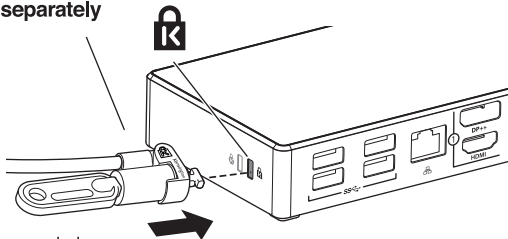

Recommended  
K65020WW MicroSaver® 2.0 Keyed Lock

Sold separately

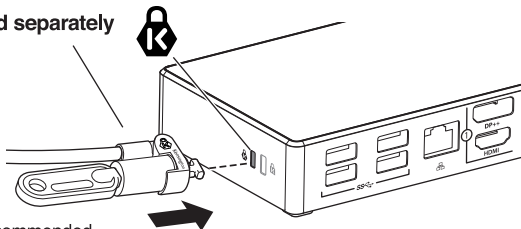

Recommended  
K64444WW NanoSaver™ Keyed Laptop Lock

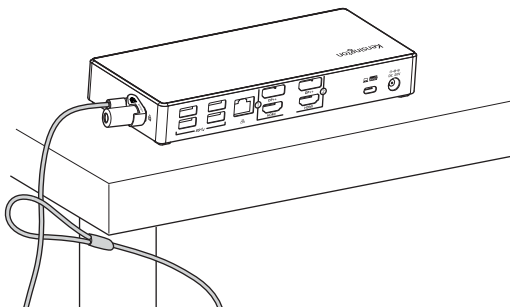



Kensington and the ACCO name and design are registered trademarks of ACCO Brands. All other registered and unregistered trademarks are the property of their respective owners. ©2020 Kensington Computer Products Group, a division of ACCO Brands. Any unauthorized copying, duplicating, or other reproduction of the contents hereof is prohibited without written consent from Kensington Computer Products Group. All rights reserved. 05/20



**Kensington Computer Products Group**  
A Division of ACCO Brands  
1500 Fashion Island Blvd, 3rd Floor  
San Mateo, CA 94404, USA

**Importer:**

LEITZ ACCO Brands GmbH & Co KG  
Siemensstraße 64  
70469 Stuttgart  
Germany

**ACCO Brands Canada Inc**

7381 Bramalea Rd  
Mississauga, ON L5S 1C4  
<https://accobrandscanada.com/>

**ACCO Brands Australia - Kensington**  
2 Coronation Avenue  
Kings Park NSW 2148  
Australia

**ACCO Brands Chile S.A.,**

Avda. Presidente Riesco # 5711,  
oficina 201  
Las Condes, Santiago, Chile  
CP 7561114  
[www.accobrand.cl](http://www.accobrand.cl)

**Importado e Distribuído por:**

Tilibra Produtos De Papelaria Ltda.  
CNPJ: 44.990.901/0001-43  
Rua Aymorés, 6-9 – Bauru/SP – Brasil  
CEP 17013-900  
[sac@tilibra.com.br](mailto:sac@tilibra.com.br)

**Dystrybutor:**

Essele Polska Sp. z o.o., ul.  
Przemysłowa 11A, 26-900  
Kozienice

**Forgalmazza:**

Essele Kft, Váci út 76. V. torony  
I. emelet,  
1133 Budapest,  
Magyarország

**Distributor:**

Essele Sales SRL,  
Gheorghe Titeica 121C,  
Sector 2, București,  
România

**Distribútor:**

Essele, s.r.o., V Lužích 818,  
142 00 Praha 4,  
Česká republika

**Импортер:**

ООО «Эссельте», Россия,  
125040, Москва, 3-я улица  
Ямского поля, д.18, тел.  
+7(495)933-27-63

**ДИСТРИБЬЮТОР:**

Essele Polska Sp. z o.o., ul.  
Przemysłowa 11A, 26-900  
Kozienice  
Импортертаушы: "АБДИ Компани" АҚ,  
Алматы қ., Сейфуллин даңғ. 465/191

**Дистрибутор:**

Essele Polska Sp. z o.o., вулиця  
Пшемислова, 11А, 26-900 Козеніц

**广州市爱珂贸易有限公司**

广州市天河区林和西路159号  
中泰国际北塔5楼, 501/701室  
邮编: 510620  
电话: 400 600 4599  
网址: <https://www.kensington.com/zh-CN>  
邮箱: [infocn@kensington.com](mailto:infocn@kensington.com)

**アコ・ブランド・ジャパン株式会社**

〒164-8721  
東京都中野区本町1-32-2  
ハーモニータワー14F  
<https://www.kensington.com/ja-JP>  
E-MAIL: [JP.Kensington@acco.com](mailto:JP.Kensington@acco.com)