

Kensington®

SD4900P USB-C & USB 3.0 Triple 4K Docking Station

QUICK START GUIDE

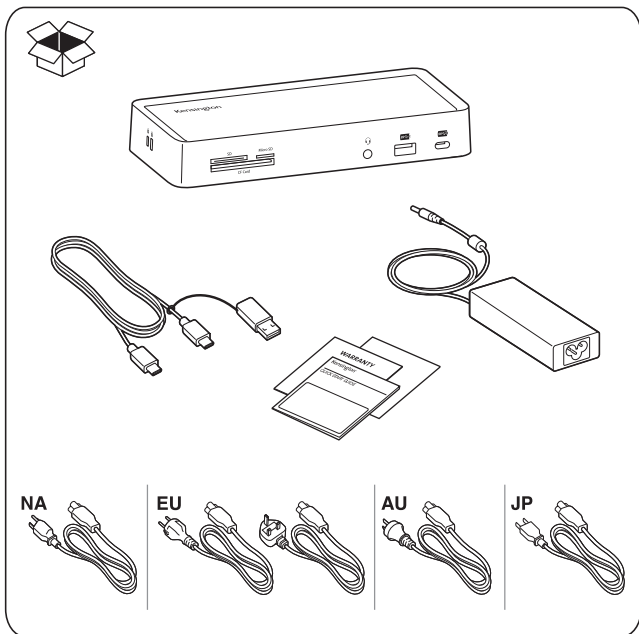

Register Now!

www.kensington.com/register

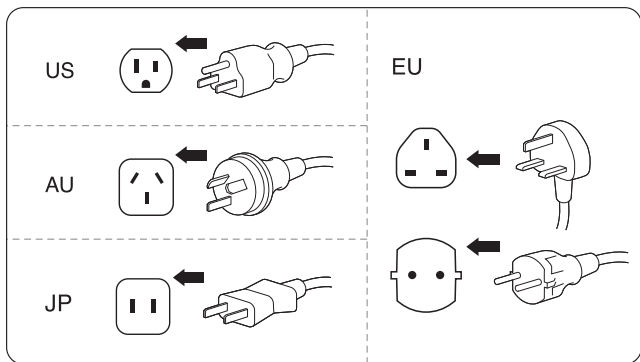
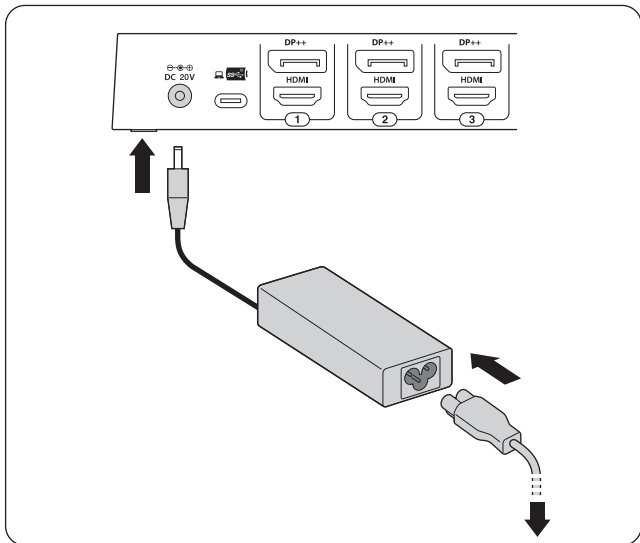
1

2

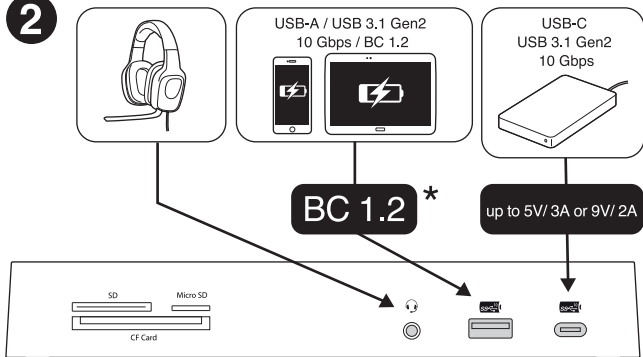

* USB Battery Charging 1.2-compliant devices (up to 5V/ 2.4A for Apple Devices)

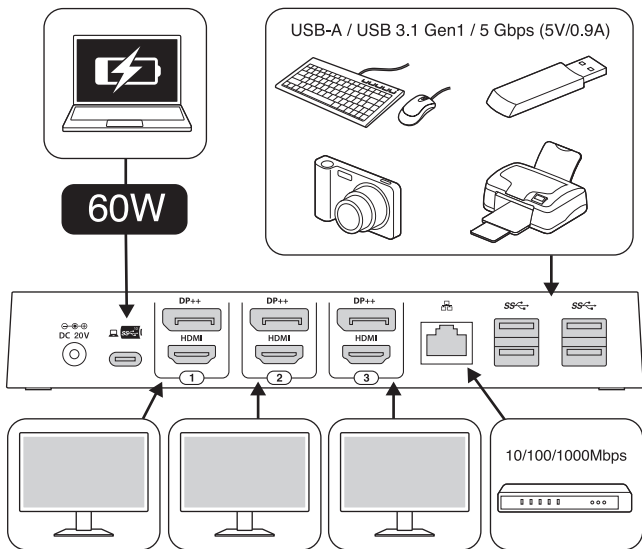

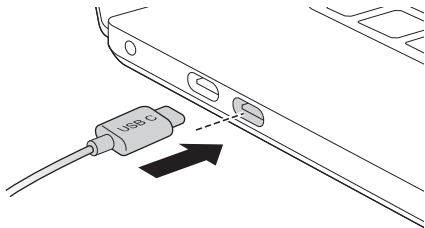
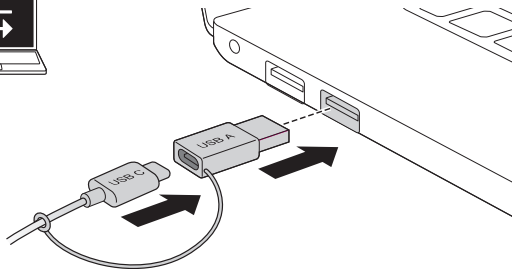
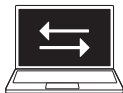
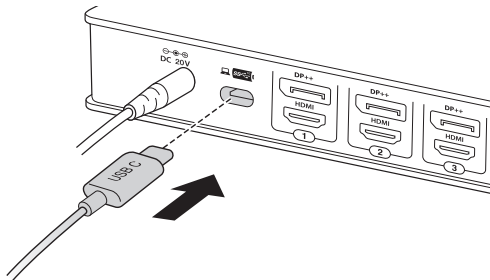
3**a****b****4**

a

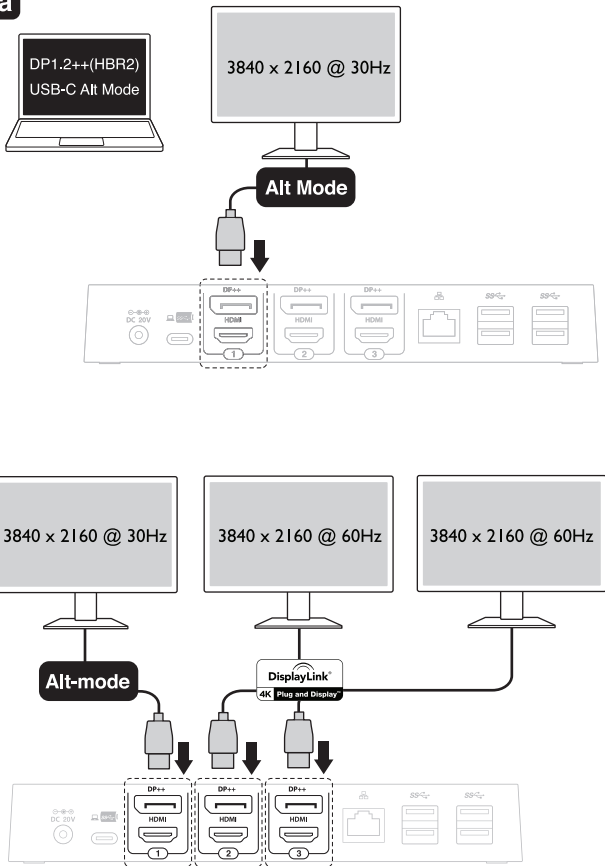

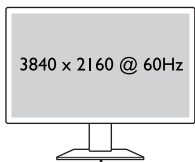
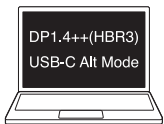
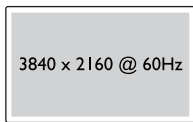
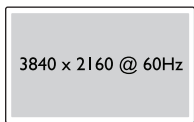
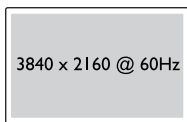
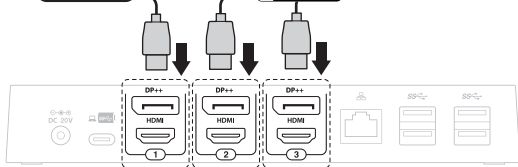
b**Alt Mode****Alt-mode****DisplayLink®
4K Plug and Display™**

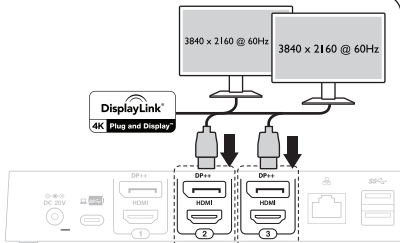
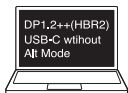
C**6**

Windows® 10 / macOS / Chrome OS



www.kensington.com/software
www.displaylink.com/downloads

...

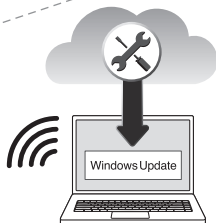

Windows® Update

?

www.kensington.com/support

Sold separately

1

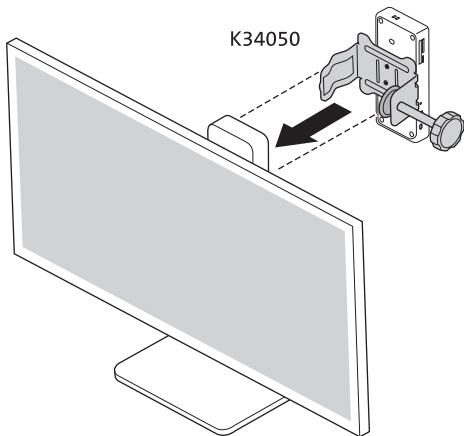

2

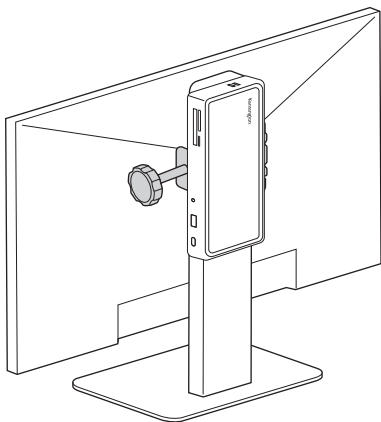

Sold separately



Recommended
K65020WW MicroSaver® 2.0 Keyed Lock

Sold separately

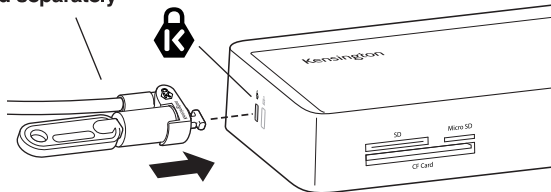

Recommended
K64444WW NanoSaver™ Keyed Laptop Lock

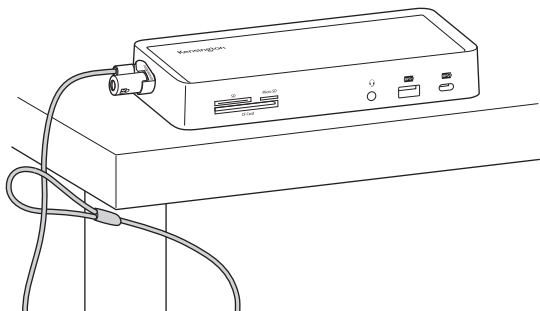

Sold separately

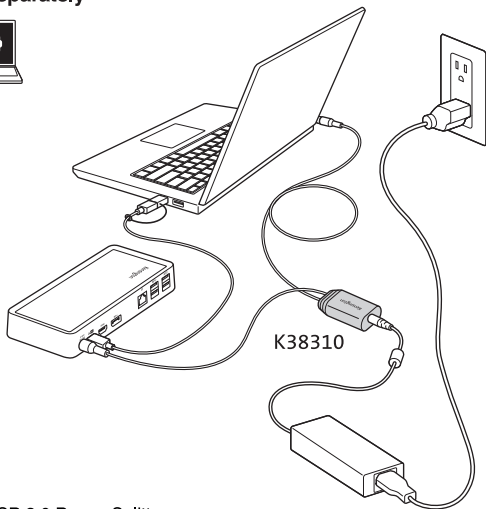

K38310

60W USB 3.0 Power Splitter

Kensington and the ACCO name and design are registered trademarks of ACCO Brands. All other registered and unregistered trademarks are the property of their respective owners.

©2019 Kensington Computer Products Group, a division of ACCO Brands. Any unauthorized copying, duplicating, or other reproduction of the contents hereof is prohibited without written consent from Kensington Computer Products Group. All rights reserved. 7/19

 Kensington Computer Products Group
A Division of ACCO Brands
1500 Fashion Island Blvd, 3rd Floor
San Mateo, CA 94404



K36800

901-9705-00