

Kensington®

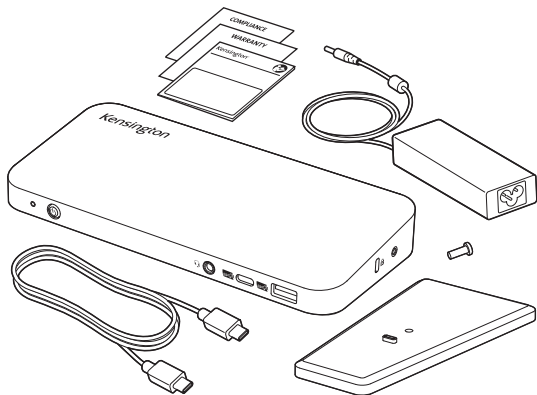

SD4840P USB-C Triple Video Driverless Dock



US



EU

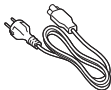

UK



ANZ/CN



JP

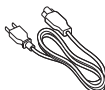

[kensington.com/register](https://www.kensington.com/register)

1

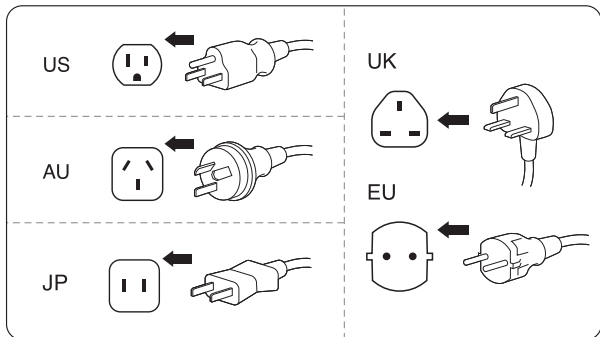
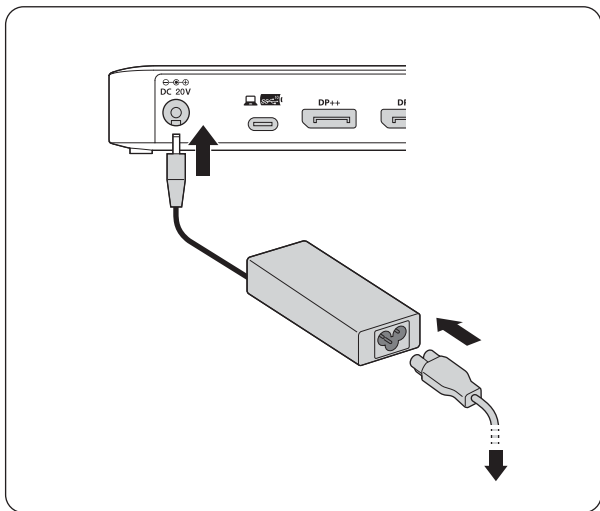

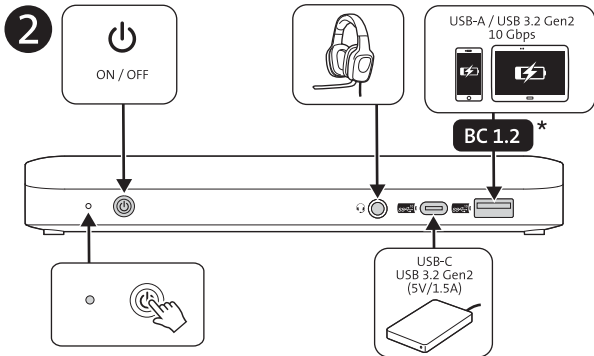

* USB Battery Charging 1.2 - compliant devices (up to 5V/ 1.5A, and 2.4A for Apple Devices)

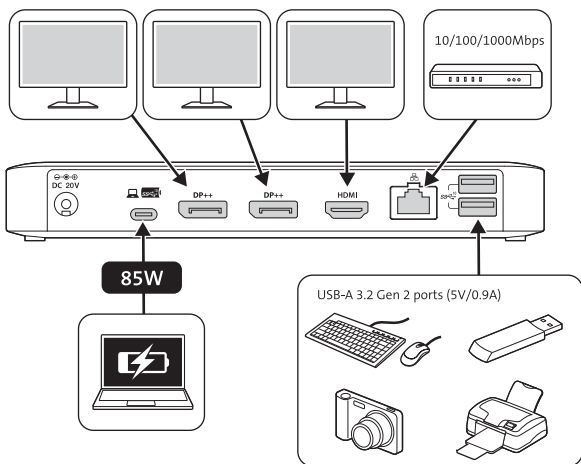

3

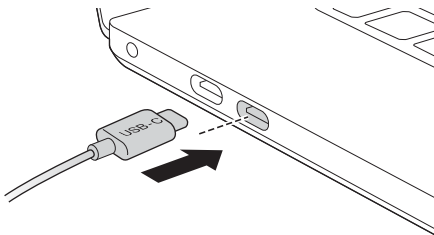

4

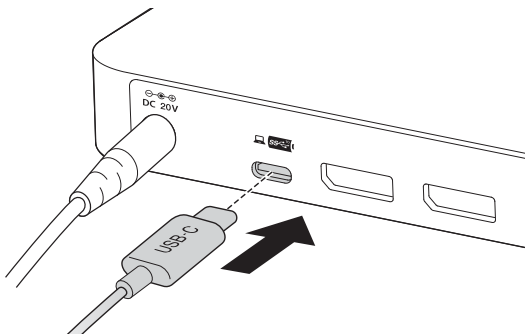

5



| HBR2 (DP-1.2) | 3840*2160 @30Hz | 1920*1080 @60Hz | 1920*1080 @30Hz |
|-----------------------|-----------------|-----------------|-----------------|
| HBR3 (DP-1.4) | 3840*2160 @30Hz | 2560*1440 @60Hz | 1920*1080 @60Hz |
| HBR3 (DP-1.4) +DSC1.2 | 3840*2160 @60Hz | 3840*2160 @60Hz | 3840*2160 @30Hz |

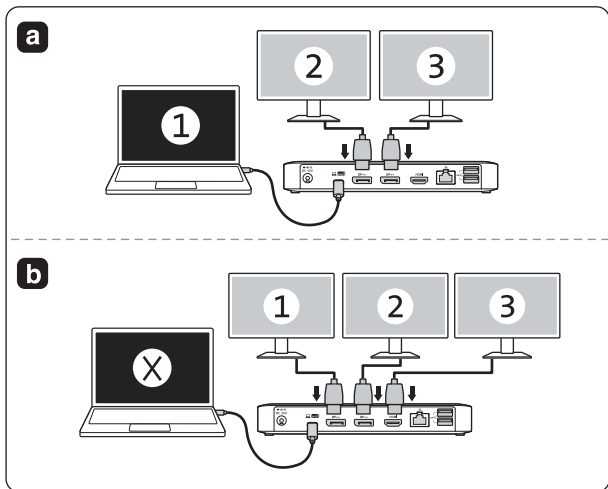

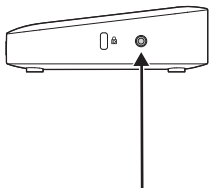

a

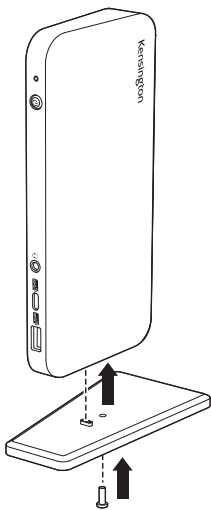

b

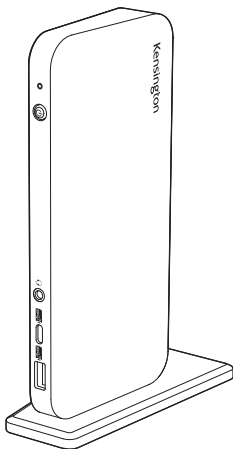

Sold separately

K-Lock secure
your device safety

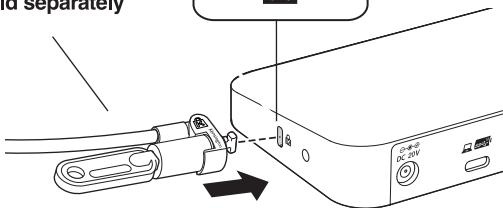

Recommended
K65020WW MicroSaver®2.0 Keyed Lock

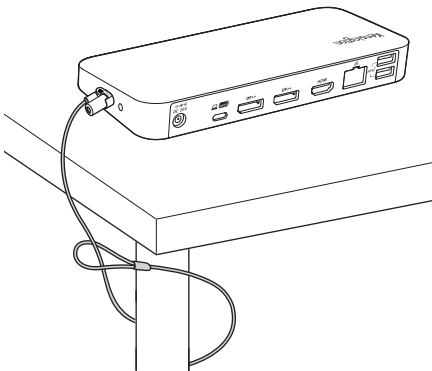

Kensington® and Security Slot are registered trademarks of ACCO Brands. Windows is a registered trademark of Microsoft Corporation in the U.S. and/or other countries. USB-C is a trademark of USB Implementers Forum. All other trademarks are the property of their respective owners.

©2023 Kensington Computer Products Group, a division of ACCO Brands.

Patents: <https://www.accobrand.com/patents/>

この装置は、クラスB機器です。この装置は、住宅環境で使用することを目的としていますが、この装置がラジオやテレビジョン受信機に近接して使用されると、受信障害を引き起こすことがあります。

取扱説明書に従って正しい取り扱いをして下さい。

VCCI - B

