

Kensington®

SafeGrip™

Rugged Case & Stand for iPad Air™ and iPad Air™ 2

QUICK START GUIDE

GUIDE DE DEMARRAGE RAPIDE

KURZANLEITUNG

SNELSTARTGIDS

GUIDA RAPIDA

GUÍA RÁPIDA

GYORSKALAUZ

PŘÍRUČKA ZAČÍNÁME

SZYBKI START

КРАТКОЕ РУКОВОДСТВО

ПОЛЬЗОВАТЕЛЯ

MANUAL DE INÍCIO RÁPIDO

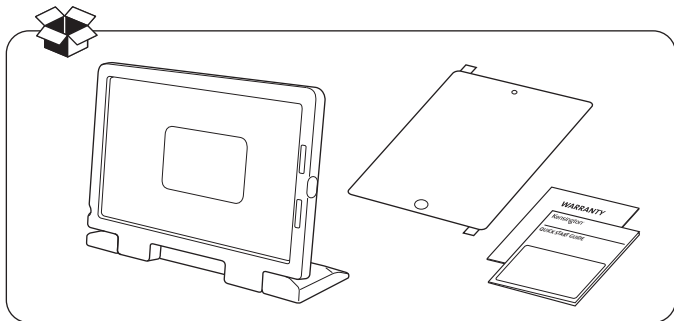

Register Now!

Enregistrer maintenant !

Jetzt registrieren!

Nu registreren

Registrar ahora

Registra adesso

Regisztráljon most!

Zaregistrujte se nyní!

Zarejestruj się!

Зарегістроваться!

Registe-se agora!

register.kensington.com

1

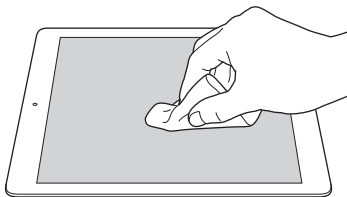

2

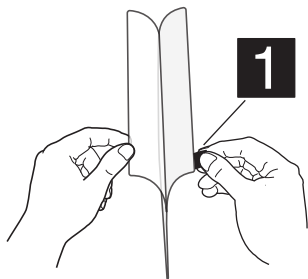

3

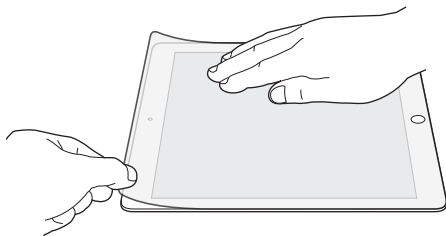

4

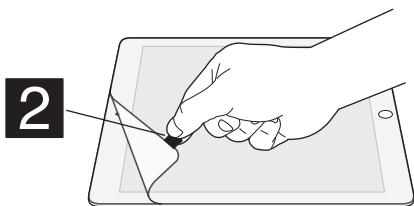

5

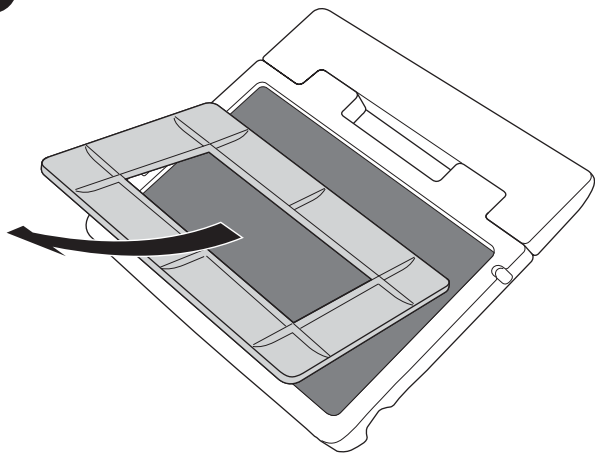

6

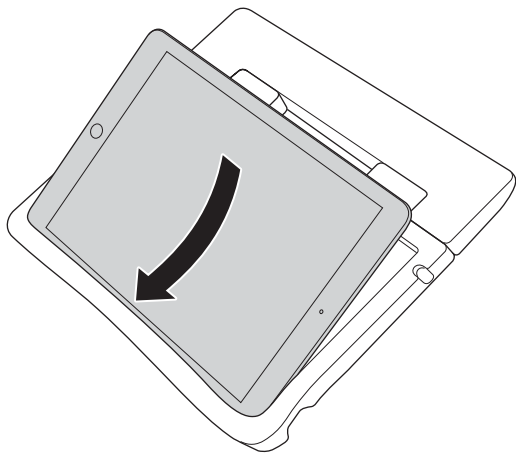

7

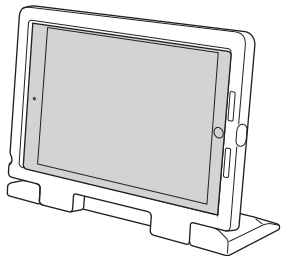
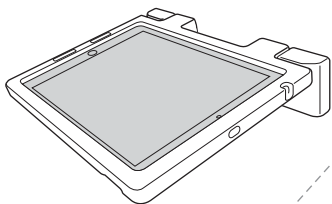
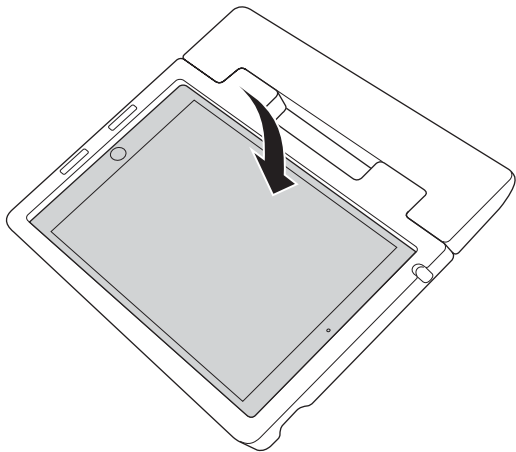

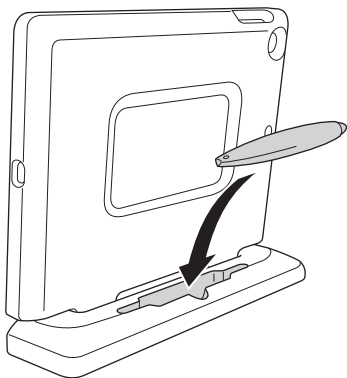

iPad & stylus (K97185WW) not included

iPad et stylet (K97185WW) non fournis

iPad und Eingabestift (K97185WW) nicht enthalten

iPad en stylus (K97185WW) niet inbegrepen

iPad e penna stilo (K97185WW) non inclusi

iPad y lápiz óptico (K97185WW) no incluidos

Az iPad és a toll (K97185WW) nem tartozék

Tablet iPad a dotykové pero (K97185WW) nejsou součástí balení

Tablet iPad i rysik (K97185WW) nie jest dołączony do zestawu

iPad и стилус (K97185WW) не включены

iPad e stylus (K97185WW) não incluídos

Technical Support / Assistance technique / Technischer Support /
 Technische ondersteuning / Supporto tecnico / Asistencia técnica /
 Műszaki támogatás / Technická podpora / Pomoc techniczna /
 Техническая поддержка / Assistência técnica

Australia	1300 881 931	Nederland	010 713 1882
België / Belgique	02 401 2395	New Zealand	0800 539 26273
Brasil	14 3235-4003	Norway	80017520
Canada	1 800 268 3447	Österreich	0800 677 873
Denmark	80 250966	Polska	22 570 18 00
Deutschland	0692 222 3654	Portugal	800855802
España	911 146 735	Russia	007 495 933 5163
Finland	0800 9 15697	Schweiz / Suisse	044 580 6667
France	01 7671 0404	Sweden	08 5033 6577
Hungary	06 20 9430 612	United Kingdom	0203 364 5390
Ireland	01 431 1395	United States	1 800 535 4242
Italia	02 3604 7030	International Toll	+31 53 484 9135
México	55 15 00 57 00		



Kensington Computer Products Group
A Division of ACCO Brands
 333 Twin Dolphin Drive, 6th Floor
 Redwood Shores, CA 94065



ACCO Brands Europe

A Division of ACCO Brands Europe
 Oxford House, Oxford Road
 Aylesbury, Buckinghamshire,
 HP21 8SZ
 United Kingdom

ACCO Brands Canada Inc

7381 Bramalea Rd
 Mississauga,
 ON L5S 1C4

ACCO Australia

Level 2, 8 Lord St
 Botany NSW 2019
 Australia

**Importado por ACCO Mexicana
 S.A. de C.V.**

Circuito de la Industria Norte # 6,
 Corredor Industrial Toluca Lerma,
 Lerma México Cp. 52004
 R.F.C. AME640229-1W3

Acco Brands Chile S.A.,

Avda. San Josemaria
 Escrivá de Balaguer Nº5773
 Vitacura, C.P. 7640870
 Santiago, Chile

Importado e Distribuído por:

TILIBRA PRODUTOS DE PAPELARIA LTDA.
 CNPJ: 44.990.901/0001-43
 Rua Aimorés, 6-9 – Bauru/SP – Brasil
 CEP 17013-900
www.kensington.com.br

Made in China

www.kensington.com

Kensington and ACCO are registered trademarks of ACCO Brands. The Kensington Promise is a service mark of ACCO Brands. SafeGrip is a trademark of ACCO Brands. iPad Air is a trademark of Apple Inc., registered in the U.S. and other countries. All other registered and unregistered trademarks are the property of their respective owners. Patents pending.

© 2014 Kensington Computer Products Group, a division of ACCO Brands. Any unauthorized copying, duplicating, or other reproduction of the contents hereof is prohibited without written consent from Kensington Computer Products Group. All rights reserved. 12/14

K97363
 901-3034-02