

Kensington®

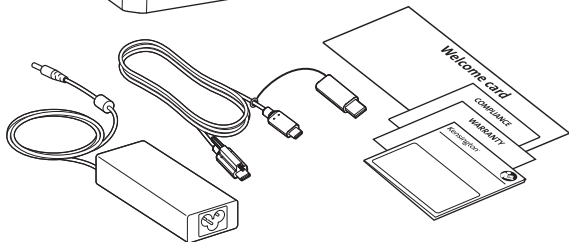

SD4790-MAC EQ USB-C® Triple 4K Docking Station for MacBook
Station d'accueil SD4790-MAC EQ USB-C® triple 4K pour MacBook

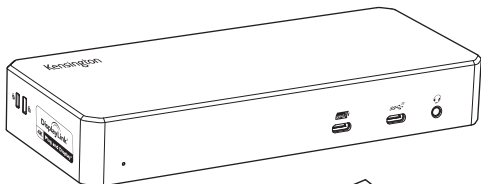

US | É.-U.



EU



UK | GB



AU/CN



JP



[kensington.com/register](https://www.kensington.com/register)

1

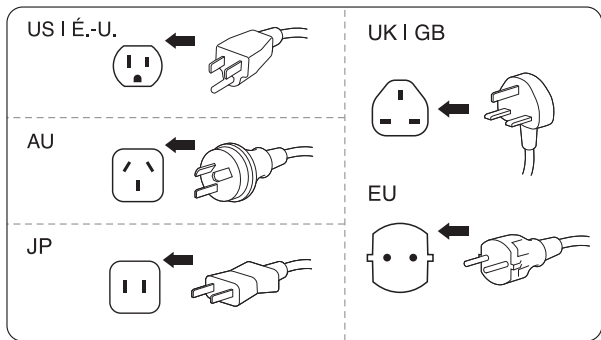
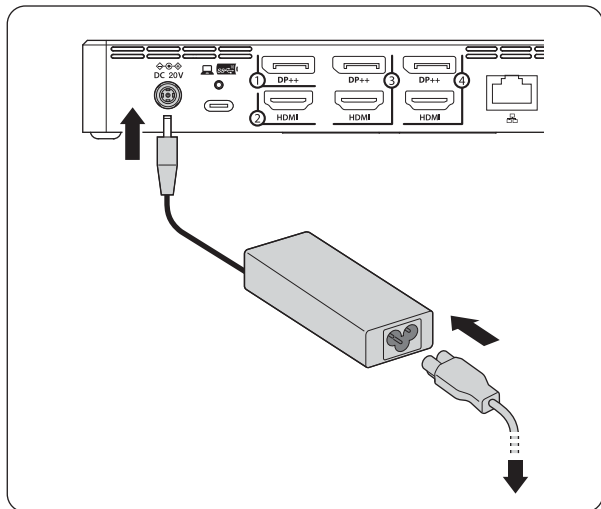

2

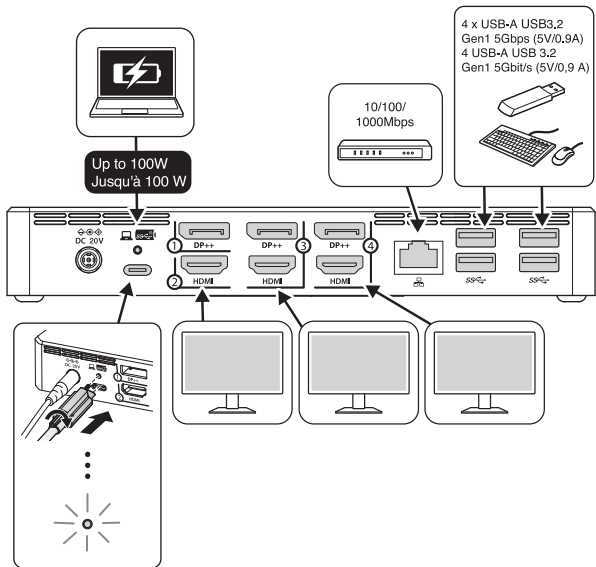
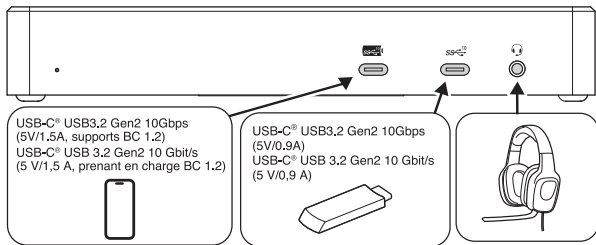

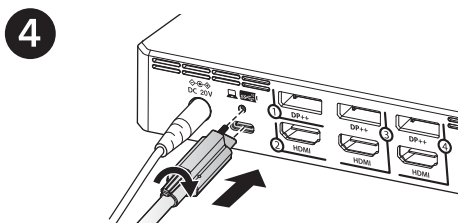
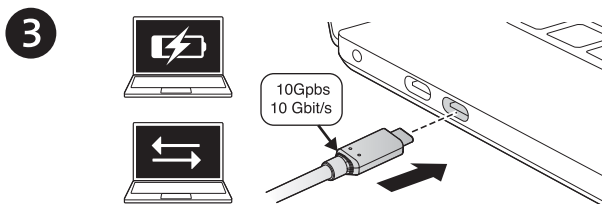
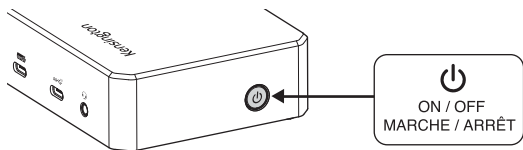

5

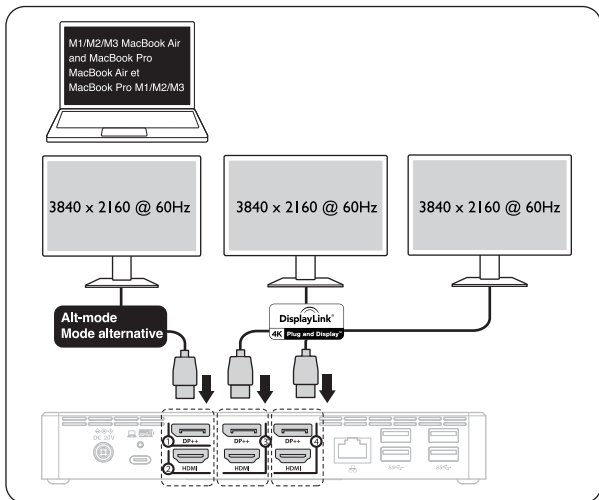

6

macOS

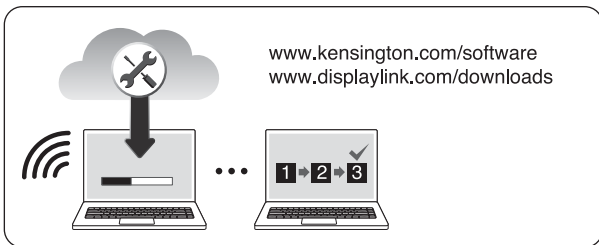

www.kensington.com/support

Sold separately / Vendu séparément

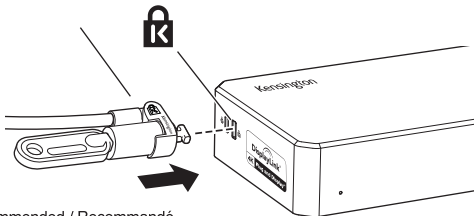

Recommended / Recommandé

K65020WW MicroSaver® 2.0 Keyed Laptop Lock

K65020WW Verrou à clé MicroSaver® 2.0 pour ordinateur portable

Sold separately / Vendu séparément

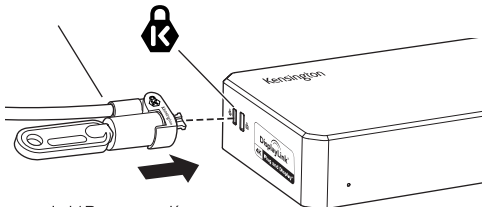



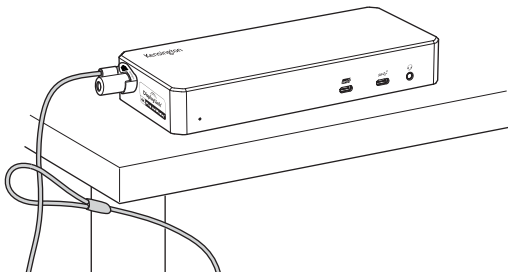

Recommended / Recommandé

K65021WW Slim NanoSaver® 2.0 Keyed Laptop Lock

K65021WW Verrou à clé mince NanoSaver® 2.0 pour ordinateur portable



	<p>MacBook Air or MacBook Pro, including M1/M2/M3 chipsets: base, Pro, and Max MacBook Air ou MacBook Pro, y compris les jeux de puces M1/M2/M3 : base, Pro et Max.</p>
	<p>Up to 4K (3840 x 2160) @ 60Hz Jusqu'à 4K (3840 x 2160) à 60 Hz</p>
	<p>Up to 4K (3840 x 2160) @ 60Hz Jusqu'à 4K (3840 x 2160) à 60 Hz</p>
	<p>Up to 4K (3840 x 2160) @ 60Hz Jusqu'à 4K (3840 x 2160) à 60 Hz</p>

EN *This Dock with USB-C® Gen2 connectivity is MacBook compatible, limited to 10Gbps bandwidth.

FR *Cette station d'accueil avec connectivité USB-C® Gen2 est compatible MacBook, limitée à une bande passante de 10 Gbit/s.



www.kensington.com/support

Kensington® is a registered trademark of ACCO Brands. Mac and macOS are trademarks of Apple Inc., registered in the U.S. and other countries and regions. All other registered and unregistered trademarks are the property of their respective owners.

© 2024 Kensington Computer Products Group, a division of ACCO Brands.

Patents: <https://www.accobrand.com/patents/>

Kensington® est une marque déposée d'ACCO Brands. Mac et macOS sont des marques commerciales d'Apple Inc., déposées aux États-Unis et dans d'autres pays et régions. Toutes les autres marques déposées et non déposées sont la propriété de leurs propriétaires respectifs.

© 2024 Kensington Computer Products Group, une division d'ACCO Brands.

Brevets : <https://www.accobrand.com/patents/>

