

Kensington®

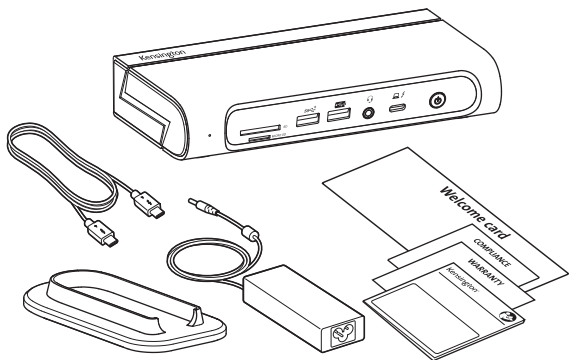

SD5800T Thunderbolt™ 4 and USB4® Quad Video Docking Station



US



EU

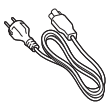

UK



AU/CN



JP



kensington.com/register

1

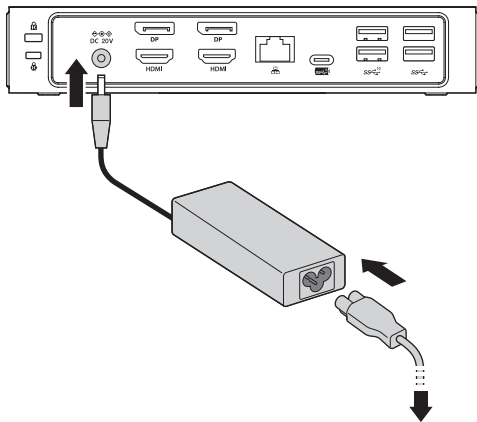

US

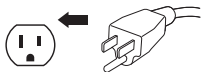

AU



JP

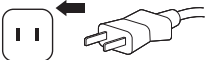

UK

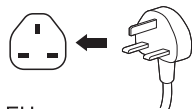

EU

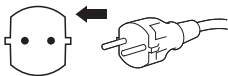

2

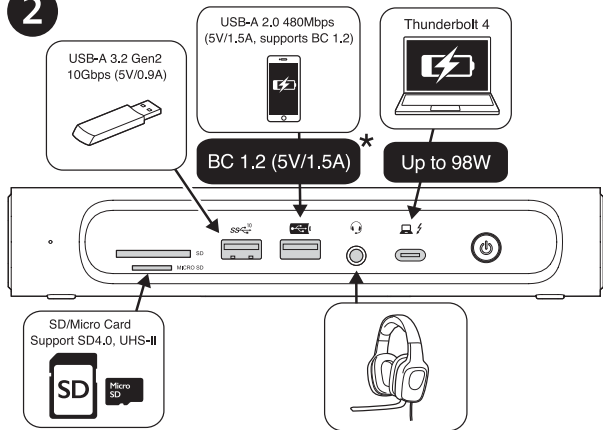

* USB Battery Charging 1.2-compliant devices

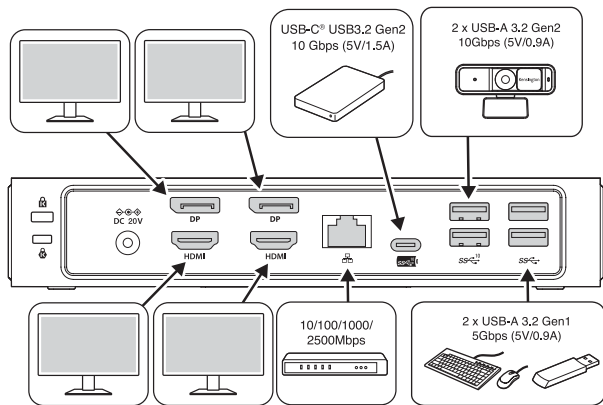

3

a

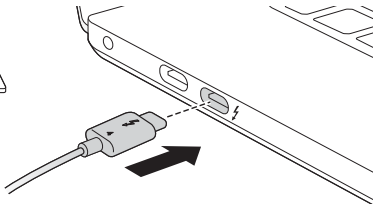
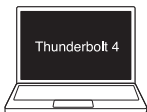



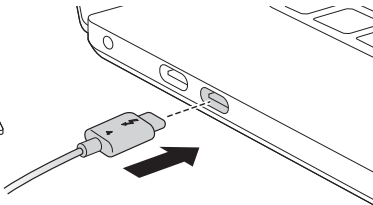
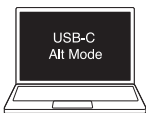

b

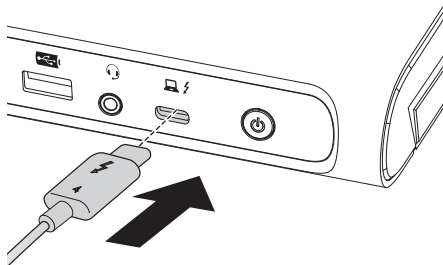





4



5

				
Thunderbolt™ 3** / Thunderbolt™ 4 / USB4 (Windows)	Up to 8K @ 60Hz* (HDMI) Up to 8K @ 30Hz* (DP)	Up to 4K @ 60Hz	Up to 4K @ 60Hz*	Up to 4K @ 60Hz*
USB-C Alt Mode*** (Windows)	Up to 4K @ 60Hz	Up to 4K @ 60Hz*	Up to 4K @ 30Hz*	Up to 2K @ 60Hz*
MacBook M1/M2/M3 Pro and Max chipsets.	Up to 6K @ 60Hz	Up to 6K @ 60Hz*	X	X
iPad & MacBook M1/M2/M3 base chipsets.	Up to 4K @ 60Hz	X	X	X

				
Thunderbolt™ 3** / Thunderbolt™ 4 / USB4 (Windows)	Up to 4K @ 120Hz* or 1440p @ 240Hz*	Up to 1080p @ 120Hz	Up to 1080p @ 120Hz	Up to 1080p @ 120Hz*

EN *Support for Display Stream Compression (DSC) is based on the capabilities of the host device and monitor.
**Some Thunderbolt™ 3 laptops may only support up to dual display 4K @ 60Hz.
***The dock capabilities are reduced when connected to a USB-C Alt Mode laptop with up to a 10 Gbps bandwidth.
Additionally, display support may depend on the laptop device and be limited to a maximum of dual displays.

DE *Unterstützung von Display Stream Compression (DSC) basiert auf den Fähigkeiten von Host-Gerät und Monitor.
**Einige Thunderbolt™ 3-Laptops unterstützen möglicherweise nur bis zu zwei Anzeigergeräte mit 4K bei 60Hz.
***Die Docking-Fähigkeiten sind bei Verbindung mit einem USB-C-Alt-Mode-Laptop mit bis zu 10 Gb/s Bandbreite reduziert. Zudem könnte die Anzeigeunterstützung vom Laptop abhängen und ist auf maximal zwei Anzeigergeräte beschränkt.

FR *La prise en charge de la fonctionnalité Display Stream Compression (DSC) est basée sur les capacités de l'appareil hôte et du moniteur.
**Certains ordinateurs portables Thunderbolt™ 3 peuvent ne prendre en charge que le double affichage 4K à 60Hz.
***Les capacités de la station d'accueil sont réduites lorsqu'elle est connectée à un ordinateur portable en USB-C Alt Mode avec une bande passante allant jusqu'à 10 Gbit/s.
De plus, la prise en charge de l'affichage peut dépendre de l'ordinateur portable et être limitée à au maximum un double affichage.

IT *Il supporto per la compressione del flusso di visualizzazione (DSC) si basa sulle capacità del dispositivo host e del monitor.
**Alcuni laptop Thunderbolt™ 3 possono supportare solo un doppio display 4K a 60Hz.

***Le capacità della base sono ridotte se collegata a un laptop USB-C Alt Mode con larghezza di banda fino a 10 Gbps. Inoltre, il numero di display supportato può dipendere dal laptop ed essere limitato a un massimo di due display.

ES *La compatibilidad con Display Stream Compression (DSC) depende de las capacidades del dispositivo host y del monitor.

**Es posible que algunos portátiles Thunderbolt™ 3 solo admitan hasta doble pantalla 4K a 60Hz.

***Las capacidades de la base se reducen cuando se conecta a un portátil USB-C Alt Mode con un ancho de banda de hasta 10 Gbps.

Además, la compatibilidad con pantallas puede depender del dispositivo portátil y estar limitada a un máximo de dos pantallas.

PT *O suporte de Compressão da transmissão do ecrã (DSC) tem por base as capacidades do dispositivo anfitrião e do monitor.

**Alguns computadores portáteis Thunderbolt™ 3 podem suportar apenas a visualização dupla 4K @ 60Hz.

***As capacidades de ancoragem são reduzidas quando ligada a um computador portátil USB-C Alt Mode com uma largura de banda de até 10 Gbps.

Além disso, o suporte do ecrã pode depender do computador portátil e ser limitado a um máximo de visualizações duplas.

CN *是否支持显示流压缩 (DSC)，这基于主机设备和显示器的功能。

** 部分Thunderbolt™ 3笔记本电脑仅支持4K @ 60Hz双显。

*** 当连接到最高带宽为10Gbps的USB-C Alt模式笔记本电脑时，扩展坞性能会降低。

此外，显示支持可能取决于笔记本电脑设备，并且也受到双显最大值的限制。

JP *ディスプレイストリーム圧縮 (DSC) のサポートは、ホストデバイスとモニターの能力に基づいています。

**一部の Thunderbolt™ 3ノートパソコンは、デュアルディスプレイ 4K @ 60Hz までサポートできる場合があります。

***10 Gbps以下の帯域幅を有するUSB-C Altモードノートパソコンに接続すると、ドックの能力が低下します。

さらに、ディスプレイのサポートはノートパソコンデバイスに依存し、デュアルディスプレイまでに制限される場合があります。

AE *يعتمد دعم تقنية ضغط تدفق العرض (DSC) على إمكانيات الجهاز المضيف وجهاز العرض.

** قد تدعم بعض أجهزة الكمبيوتر المحمولة منافذ 3 Thunderbolt™ ما يصل إلى العرض الثنائي بدقة 4K @ وتردد 60 هرتز

*** يتم تقليل إمكانيات قاعدة الإرساء عند اتصالها بجهاز كمبيوتر محمول بوضع USB-C البديل إلى ما يصل إلى نطاق تردد 10 جيجابت في الثانية.
بالإضافة إلى ذلك، قد يعتمد دعم العرض على جهاز الكمبيوتر المحمول ويقتصر على أقصى عدد من العروض الثنائية.

6

Initial Thunderbolt 4 connection for Windows

New Thunderbolt™ device have been attached

Thunderbolt™ devices were attached. In order to approve them for use this application must be run with administrator privileges.

Click OK to run the Thunderbolt™ software with administrator privileges.

OK

Cancel

6.1 Manage Thunderbolt 4 devices and settings later



6.2

View Attached Devices

Approve Attached Devices ▸

Manage Approved Device

Settings

Exit

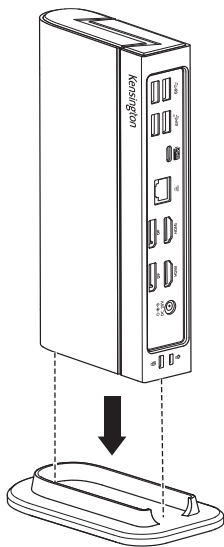
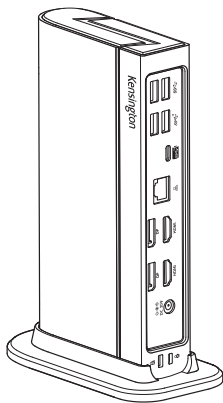

1**2**

Sold separately

1

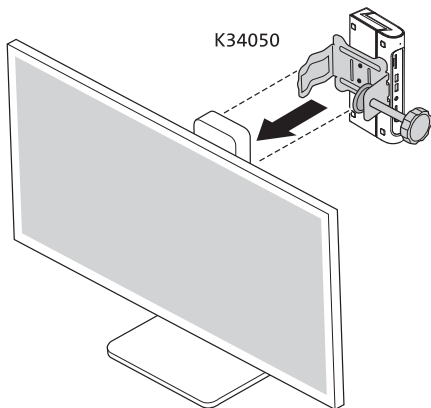

2

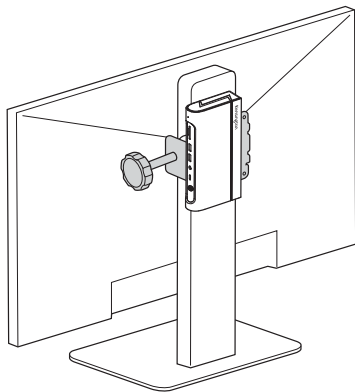

Sold separately

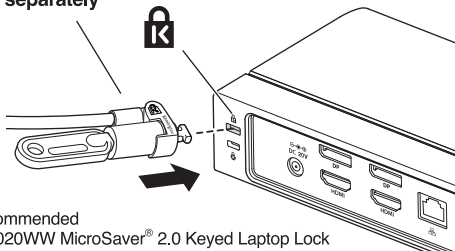

Recommended
K65020WW MicroSaver[®] 2.0 Keyed Laptop Lock

Sold separately

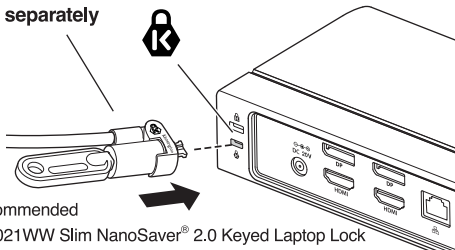

Recommended
K65021WW Slim NanoSaver[®] 2.0 Keyed Laptop Lock

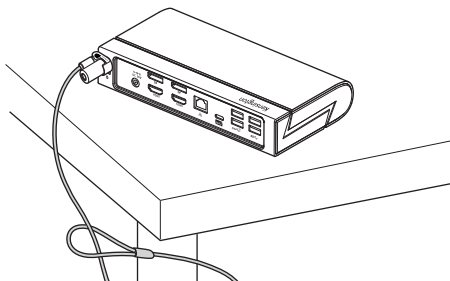



www.kensington.com/support

Kensington® is a registered trademark of ACCO Brands. All other registered and unregistered trademarks are the property of their respective owners.

© 2023 Kensington Computer Products Group, a division of ACCO Brands.

Patents: <https://www.accobrand.com/patents/>

この装置は、クラスB機器です。この装置は、住宅環境で使用することを目的としていますが、この装置がラジオやテレビの受信機に近接して使用されると、受信障害を引き起こすことがあります。

取扱説明書に従って正しい取扱いをして下さい。

VCCI - B

